

# 720A

## Kelvin-Varley Voltage Divider

Instruction Manual

P/N 294058  
March 1969  
Rev. 2 9/74



~~REV. 6/81~~  
~~5/93~~  
Update  
1 yr.  
5/94

## WARRANTY

Notwithstanding any provision of any agreement the following warranty is exclusive:

The JOHN FLUKE MFG. CO., INC., warrants each instrument it manufactures to be free from defects in material and workmanship under normal use and service for the period of 1-year from date of purchase. This warranty extends only to the original purchaser. This warranty shall not apply to fuses, disposable batteries (rechargeable type batteries are warranted for 90-days), or any product or parts which have been subject to misuse, neglect, accident, or abnormal conditions of operations.

In the event of failure of a product covered by this warranty, John Fluke Mfg. Co., Inc., will repair and calibrate an instrument returned to an authorized Service Facility within 1 year of the original purchase; provided the warrantor's examination discloses to its satisfaction that the product was defective. The warrantor may, at its option, replace the product in lieu of repair. With regard to any instrument returned within 1 year of the original purchase, said repairs or replacement will be made without charge. If the failure has been caused by misuse, neglect, accident, or abnormal conditions of operations, repairs will be billed at a nominal cost. In such case, an estimate will be submitted before work is started, if requested.

THE FOREGOING WARRANTY IS IN LIEU OF ALL OTHER WARRANTIES, EXPRESS OR IMPLIED, INCLUDING BUT NOT LIMITED TO ANY IMPLIED WARRANTY OF MERCHANTABILITY, FITNESS, OR ADEQUACY FOR ANY PARTICULAR PURPOSE OR USE. JOHN FLUKE MFG. CO., INC., SHALL NOT BE LIABLE FOR ANY SPECIAL, INCIDENTAL, OR CONSEQUENTIAL DAMAGES, WHETHER IN CONTRACT, TORT, OR OTHERWISE.

**If any failure occurs, the following steps should be taken:**

1. Notify the JOHN FLUKE MFG. CO., INC., or nearest Service facility, giving full details of the difficulty, and include the model number, type number and serial number. On receipt of this information, service data, or shipping instructions will be forwarded to you.
2. On receipt of the shipping instructions, forward the instrument, transportation prepaid. Repairs will be made at the Service Facility and the instrument returned, transportation prepaid.

### SHIPPING TO MANUFACTURER FOR REPAIR OR ADJUSTMENT

All shipments of JOHN FLUKE MFG. CO., INC., instruments should be made via United Parcel Service or "Best Way" prepaid. The instrument should be shipped in the original packing carton; or if it is not available, use any suitable container that is rigid and of adequate size. If a substitute container is used, the instrument should be wrapped in paper and surrounded with at least four inches of excelsior or similar shock-absorbing material.

### CLAIM FOR DAMAGE IN SHIPMENT TO ORIGINAL PURCHASER

The instrument should be thoroughly inspected immediately upon original delivery to purchaser. All material in the container should be checked against the enclosed packing list. The manufacturer will not be responsible for shortages against the packing sheet unless notified immediately. If the instrument is damaged in any way, a claim should be filed with the carrier immediately. (To obtain a quotation to repair shipment damage, contact the nearest Fluke Technical Center.) Final claim and negotiations with the carrier must be completed by the customer.

The JOHN FLUKE MFG. CO., INC., will be happy to answer all applications or use questions, which will enhance your use of this instrument. Please address your requests or correspondence to: JOHN FLUKE MFG. CO., INC., P.O. BOX C9090, EVERETT, WASHINGTON 98206, ATTN: Sales Dept. For European Customers: Fluke (Holland) B.V., P.O. Box 5053, 5004 EB, Tilburg, The Netherlands.

\*For European customers, Air Freight prepaid.

**John Fluke Mfg. Co., Inc., P.O. Box C9090, Everett, Washington 98206**

---

# Table of Contents

---

SECTION	TITLE	PAGE
<b>1</b>	<b>INTRODUCTION AND SPECIFICATIONS . . . . .</b>	<b>1-1</b>
	1-1. Introduction . . . . .	1-1
	1-5. Electrical Specifications . . . . .	1-1
	1-6. Mechanical and Environmental Specifications . . . . .	1-2
<b>2</b>	<b>OPERATING INSTRUCTIONS . . . . .</b>	<b>2-1</b>
	2-1. Introduction . . . . .	2-1
	2-3. Power Limitations . . . . .	2-1
	2-5. Functions of Controls and Terminals . . . . .	2-1
	2-7. Ratio Errors Caused by Loading or Leakage . . . . .	2-1
	2-18. Temperature Control . . . . .	2-3
	2-20. Power Coefficient . . . . .	2-4
	2-22. End Errors . . . . .	2-4
	2-24. Self-Calibration Procedure . . . . .	2-4
	2-26. Check Positions of the Function Switch . . . . .	2-7
	2-28. Applications of the Model 720A . . . . .	2-7
<b>3</b>	<b>THEORY OF OPERATION . . . . .</b>	<b>3-1</b>
	3-1. Introduction . . . . .	3-1
	3-3. The Basic Circuit . . . . .	3-1
	3-6. Circuit Refinements . . . . .	3-1
	3-8. The Model 720A . . . . .	3-1

**TABLE OF CONTENTS, *continued***

<b>SECTION</b>	<b>TITLE</b>	<b>PAGE</b>
<b>4</b>	<b>MAINTENANCE . . . . .</b>	<b>4-1</b>
	4-1. Introduction . . . . .	4-1
	4-4. Test Equipment Required for Maintenance . . . . .	4-1
	4-6. Preventive Maintenance . . . . .	4-1
	4-19. Calibration . . . . .	4-13
	4-28. Troubleshooting . . . . .	4-18
	4-38. Repair . . . . .	4-19
	4-41. Service Information . . . . .	4-19
<b>5</b>	<b>LIST OF REPLACEABLE PARTS . . . . .</b>	<b>5-1</b>
	5-1. Introduction . . . . .	5-1
	5-3. Columnar Information . . . . .	5-1
	5-4. How to Obtain Parts . . . . .	5-2
	5-8. Serial Number Effectivity . . . . .	5-2
<b>6</b>	<b>OPTIONS/NOT APPLICABLE</b>	
<b>7</b>	<b>GENERAL INFORMATION . . . . .</b>	<b>7-1</b>
<b>8</b>	<b>SCHEMATIC DIAGRAMS . . . . .</b>	<b>8-1</b>

---

# List of Illustrations

---

FIGURE	TITLE	PAGE
Frontispiece	Model 720A Kelvin-Varley Voltage Divider . . . . .	v
1-1	Absolute Linearity . . . . .	1-2
1-2	Stability . . . . .	1-3
1-3	Temperature Coefficient . . . . .	1-3
1-4	Power Coefficient . . . . .	1-4
2-1	Functions of Controls and Terminals . . . . .	2-2
2-2	Thevinin Equivalent Circuit . . . . .	2-3
2-3	Approximate Variation of Output Resistance With Dial Setting . . . . .	2-4
2-4	Approximate Variation of Minimum Load Resistance for 0.03 PPM of Input Loading Error . . . . .	2-5
2-5	Connections for Determining End Errors . . . . .	2-6
2-6	Typical Associated Equipment for Voltage Divider Calibration . . . . .	2-7
2-7	Equipment Connections for Calibrating a Voltage Divider . . . . .	2-8
2-8	Simplified Schematic Diagram of Voltage Divider Calibration . . . . .	2-9
2-9	Typical Associated Equipment for Measuring Voltages . . . . .	2-10
2-10	Equipment Connections for Voltage Measurements . . . . .	2-11, 2-12
2-11	Typical Associated Equipment for Measuring Unknown Voltages . . . . .	2-12
2-12	Equipment Connections for Simplified Method of Voltage Measurement . . . . .	2-13
2-13	Typical Associated Equipment for Measuring Unknown Resistance Ratios . . . . .	2-14
2-14	Equipment Connections for Determining an Unknown Resistance Value . . . . .	2-14, 2-15

LIST OF ILLUSTRATIONS, *continued*

FIGURE	TITLE	PAGE
3-1	Simplified Schematic Diagram of Basic Kelvin-Varley Divider Circuit . . . . .	3-2
4-1	Test Equipment Required for Maintenance . . . . .	4-2
4-2	Equipment Connections for Leakage Resistance Test . . . . .	4-3
4-3	Equipment Connections for Linearity Comparison Test . . . . .	4-4
4-4	Simplified Schematic Diagram of Linearity Comparison Test . . . . .	4-5
4-5	Equipment Connections for Decade Linearity Test . . . . .	4-7
4-6	Simplified Schematic Diagram of Decade Linearity Test . . . . .	4-8
4-7	“B” Decade Linearity Test . . . . .	4-9
4-8	“C” Decade Linearity Test . . . . .	4-10
4-9	“D” Decade Linearity Test . . . . .	4-11
4-10	“E” Decade Linearity Test . . . . .	4-12
4-11	“F” Decade Linearity Test . . . . .	4-13
4-12	“G” Decade Linearity Test . . . . .	4-14
4-13	Internal Function Switch . . . . .	4-16
4-14.	Equipment Connections for Self Calibration . . . . .	4-17
5-1.	720A Kelvin-Varley Voltage Divider . . . . .	5-4, 5-5
5-2.	Front Panel Assembly . . . . .	5-6
5-3.	Trimmer P/C Assembly . . . . .	5-8, 5-9
5-4.	Bridge P/C Assembly . . . . .	5-13
5-5.	“B” Decade Switch Assembly . . . . .	5-14
5-6.	“C” Decade Switch Assembly . . . . .	5-15
5-7.	“D”, “E”, “F” and “G” Decades Switch Assembly . . . . .	5-17

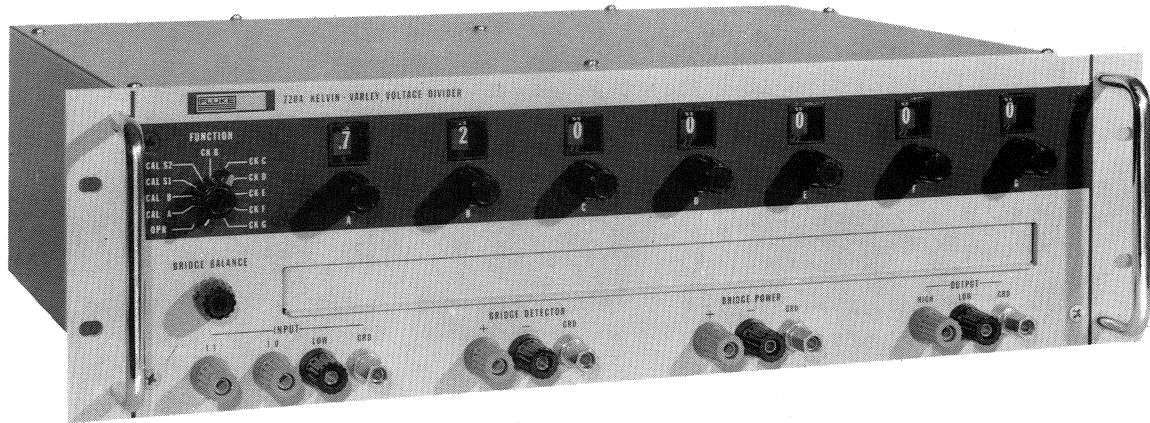

**MODEL 720A KELVIN-VARLEY VOLTAGE DIVIDER**

## Section 1

# Introduction & Specifications

### 1-1. INTRODUCTION

1-2. The Model 720A Kelvin-Varley Voltage Divider is a seven-dial primary ratio standard which meets the most exacting requirements of the standards laboratory. Absolute linearity of 0.1 ppm, temperature coefficient of linearity of 0.1 ppm/°C, and self-calibration make the 720A the most accurate instrument available for the comparison of primary and secondary voltage and resistance standards. The linearity has a small power derating coefficient of 0.2 ppm per watt which is achieved by matching the resistors' temperature coefficients close to zero. This permits operation at up to 1100 volts and 11 watts.

1-3. The Model 720A has two high input terminals. The terminal labeled INPUT 1.0 is for general use in all Kelvin-Varley applications for which direct reading, in ratio, is desired. The terminal labeled INPUT 1.1 is used for voltage measurement applications when both direct reading in voltage and over-ranging are desired. An example of this application is the measurement of standard cell voltages. Use of the 1.1 INPUT at a level of 1.1 volts in this application results in divider resolution of 0.1 microvolt and allows comparison of standard cells to within 1 microvolt.

1-4. Only thoroughly aged resistors of the highest quality are used in the Model 720A Kelvin-Varley Divider. As a result, linearity change per year will not exceed one part per million unless the instrument is subjected to abuse. To assure that the divider remains within its specifications throughout its useful life, adjustments are provided for the resistors of the first three decades. The third decade adjustments normally will be used only during annual calibration. Performing the self calibration procedure sets the adjustments of the first two decades. With reasonable care these adjustments will provide instrument accuracy of 0.1 part per million at the time of adjustment.

### 1-5. ELECTRICAL SPECIFICATIONS

#### RATIO RANGE

0 to 1.0 (1.0 INPUT TAP) and 0 to 1.1 (1.1 INPUT TAP).

#### RESOLUTION

0.1 ppm of input with 7 decades.

#### ABSOLUTE LINEARITY

(at calibration temperature and without the use of a correction chart)\*

±0.1 ppm of input at dial settings of 1.1 to 0.1.

±0.1 (10S)<sup>1/3</sup> of input at dial settings (S) of 0.1 to 0.  
(See Figure 1-1.)

#### ABSOLUTE LINEARITY STABILITY (without self-calibration)

±1.0 ppm of input/year at dial settings of 1.1 to 0.1.

±1.0 (10S)<sup>2/3</sup> ppm of input/year at dial settings (S) of 0.1 to 0.

(See Figure 1-2.)

#### *NOTE!*

*The self-calibration procedure may be used at any time to reset absolute linearity to ±0.1 ppm of input.*

#### TEMPERATURE COEFFICIENT OF LINEARITY

±0.1 ppm of input/°C maximum at dial settings of 1.1 to 0.1.

(See Figure 1-3.)

#### SHORT-TERM LINEARITY STABILITY

Under typical conditions in a standards laboratory environment (temperature maintained within ±1°C) and with an applied voltage of up to 100 volts, stability of linearity is 0.1 ppm/30 days.



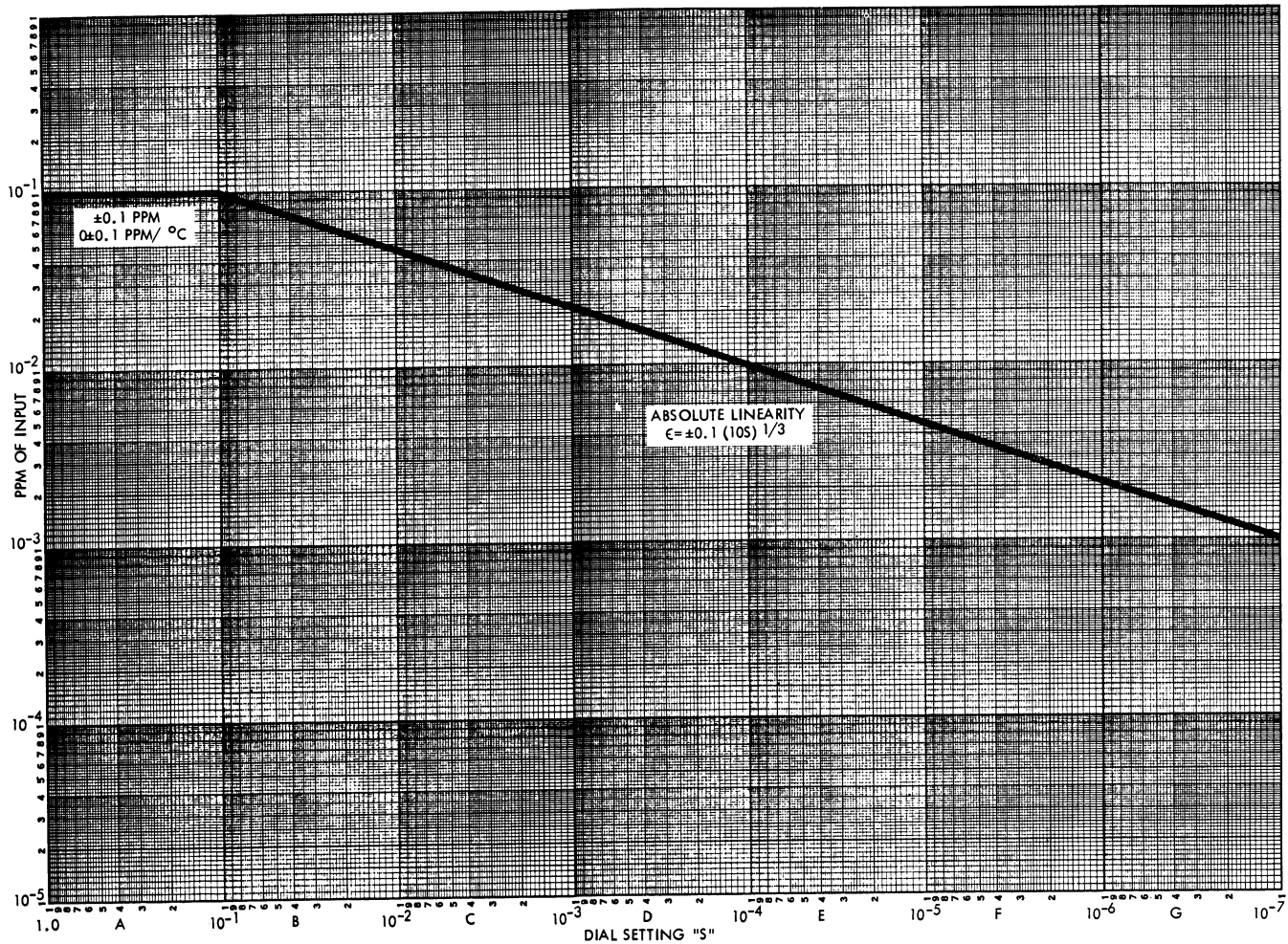

Figure 1-1. ABSOLUTE LINEARITY

**POWER COEFFICIENT OF LINEARITY**

$\pm 0.2$  ppm of input/watt maximum at dial settings of 1.1 to 0.1.

$\pm 0.2 (10S)^2$  ppm of input/watt maximum at dial settings (S) of 0.1 to 0.  
(See Figure 1-4.)

**MAXIMUM END ERRORS**

Zero error, at output low	0.004 ppm of input
Zero error, at input low	0.05 ppm of input
Full-scale error	0.05 ppm of input

**THERMAL VOLTAGES**

$\pm 0.5$  uv maximum.

**MAXIMUM INPUT POWER**

10 watts on 1.0 INPUT terminal.  
11 watts on 1.1 INPUT terminal.

\*Absolute linearity is defined as the linearity between maximum and minimum output voltages.

**MAXIMUM INPUT VOLTAGE**

1000 volts on 1.0 INPUT terminal.  
1100 volts on 1.1 INPUT terminal.

**BREAKDOWN VOLTAGE**

2000 volts to case at 10,000 feet.  
2500 volts to case at sea level.

**INPUT RESISTANCE**

100 kilohms  $\pm 0.005\%$  at 1.0 INPUT terminal at 25°C.  
110 kilohms  $\pm 0.005\%$  at 1.1 INPUT terminal at 25°C.

**TEMPERATURE COEFFICIENT OF INPUT RESISTANCE**

$\pm 1$  ppm/°C maximum.

**MAXIMUM OUTPUT RESISTANCE**

66 kilohms.

**1-6. MECHANICAL AND ENVIRONMENTAL SPECIFICATIONS****OPERATING TEMPERATURE RANGE**

0°C to 50°C (32°F to 122°F).

**NOTE!**

*When the Model 720A is used at temperatures below 15°C (59°F) or above 35°C (95°F), the range of the calibration adjustments may be*

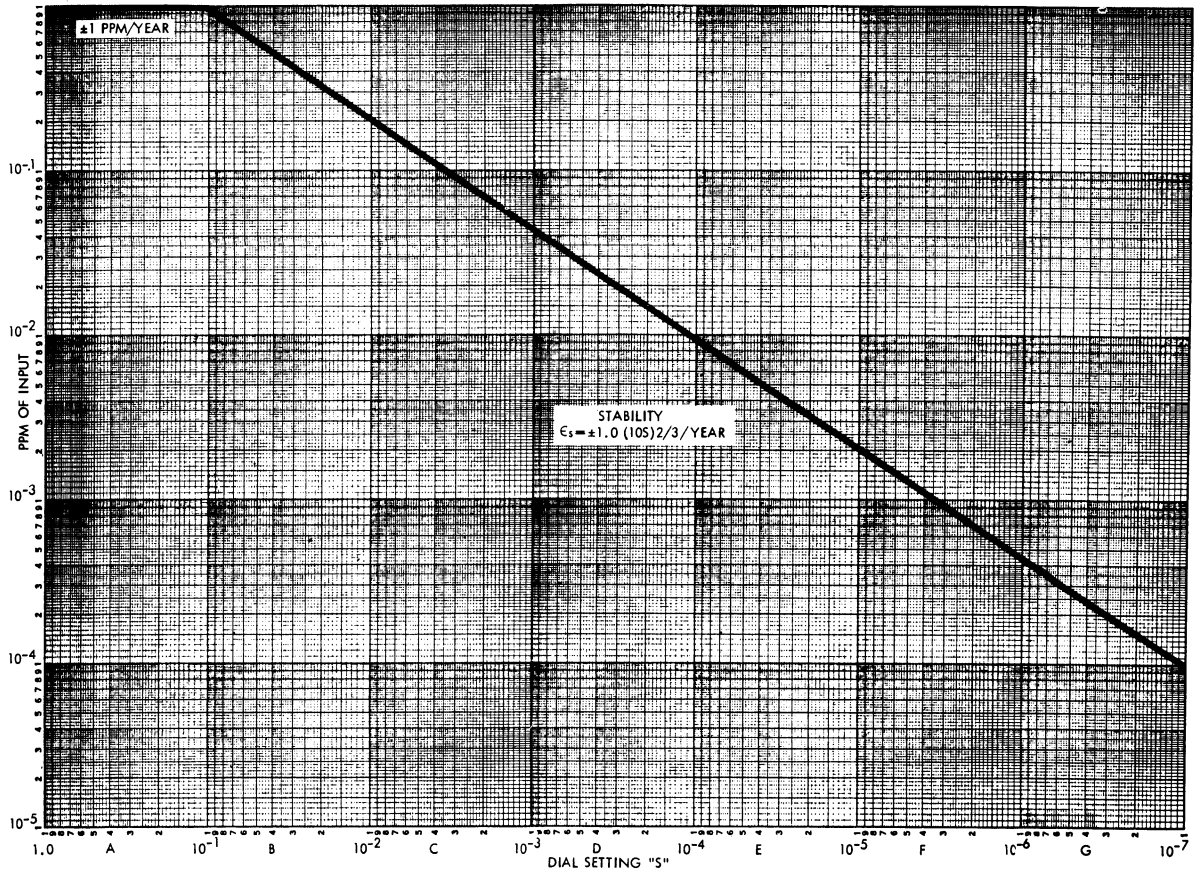

Figure 1-2. STABILITY

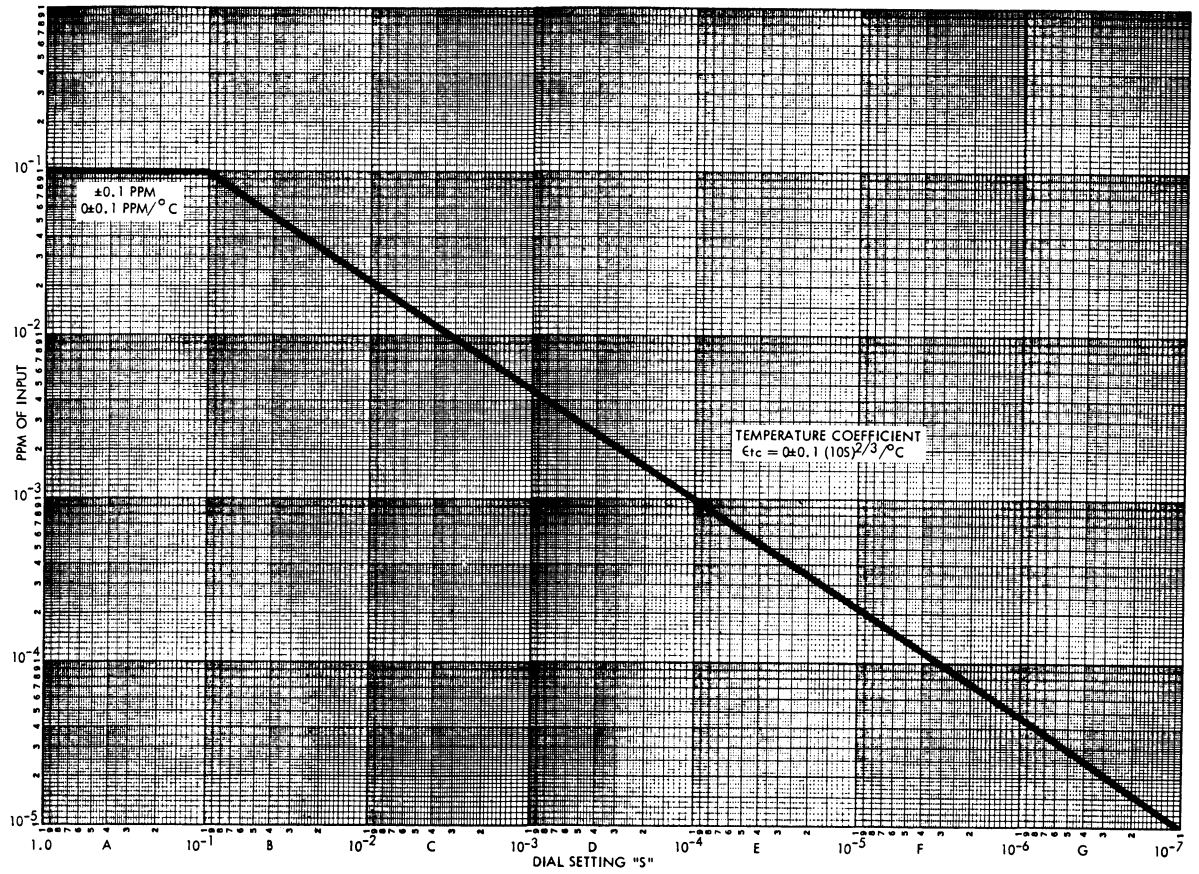

Figure 1-3. TEMPERATURE COEFFICIENT

exceeded and linearity must be derated 0.1 ppm/°C from the calibration temperature.

#### OPERATING HUMIDITY RANGE

Up to 70% relative humidity at 35°C (95°F): No derating is required.

Up to 80% relative humidity at 35°C (95°F): Linearity derating is 0.1 ppm of input for any relative humidity between 70% and 80%.

#### STORAGE TEMPERATURE RANGE

-34°C to 70°C (-29°F to 158°F).

#### SHOCK

Meets requirements of MIL-T-945A and MIL-S-901B, rigidly mounted with slides.

#### VIBRATION

Meets requirements of MIL-T-945A, rigidly mounted or rack mounted with slides.

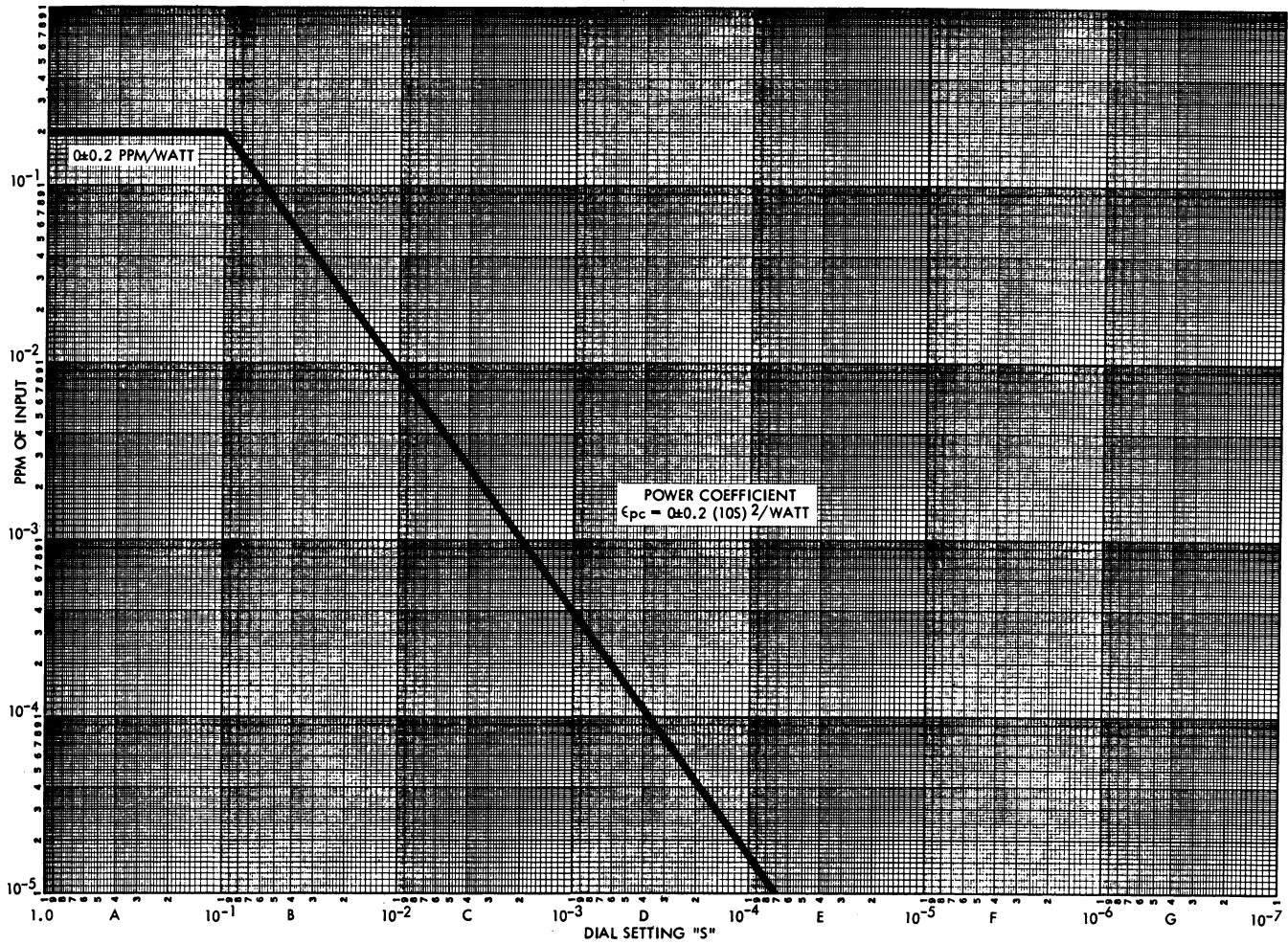

Figure 1-4. POWER COEFFICIENT



# static awareness



A Message From  
**John Fluke Mfg. Co., Inc.**

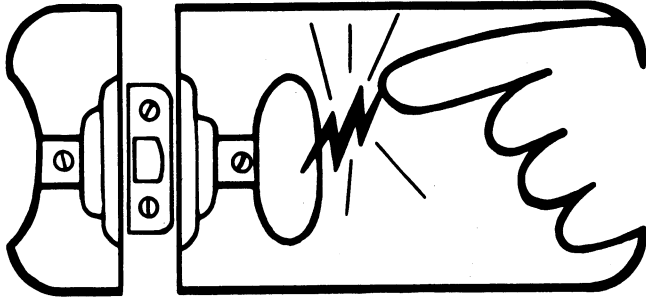

Some semiconductors and custom IC's can be damaged by electrostatic discharge during handling. This notice explains how you can minimize the chances of destroying such devices by:

1. Knowing that there is a problem.
2. Learning the guidelines for handling them.
3. Using the procedures, and packaging and bench techniques that are recommended.

The Static Sensitive (S.S.) devices are identified in the Fluke technical manual parts list with the symbol "⊗"

The following practices should be followed to minimize damage to S.S. devices.

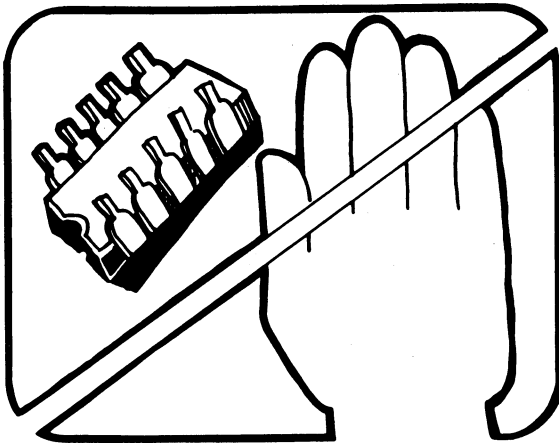

1. MINIMIZE HANDLING

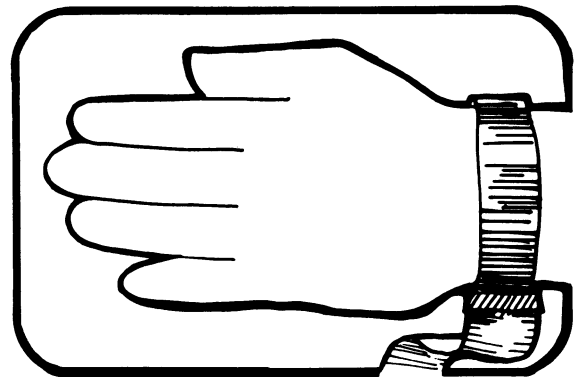

3. DISCHARGE PERSONAL STATIC BEFORE HANDLING DEVICES. USE A HIGH RESISTANCE GROUNDING WRIST STRAP.

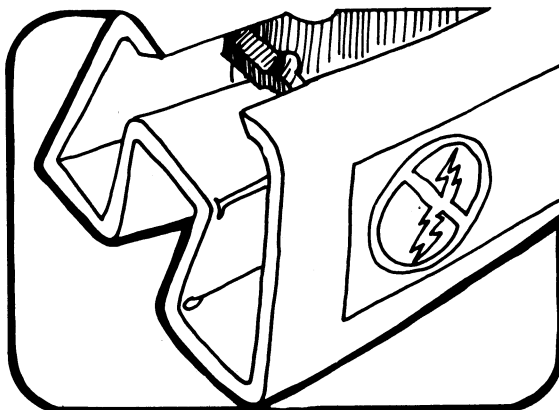

2. KEEP PARTS IN ORIGINAL CONTAINERS UNTIL READY FOR USE.

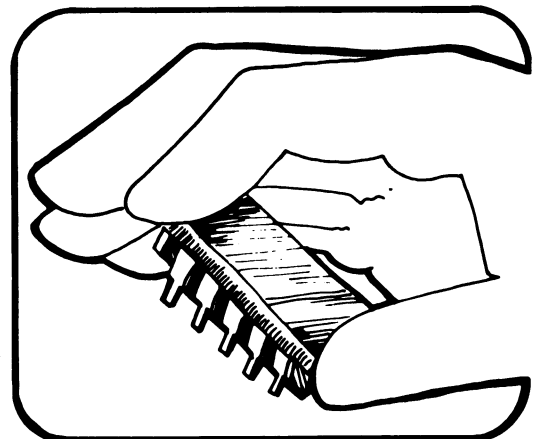

4. HANDLE S.S. DEVICES BY THE BODY

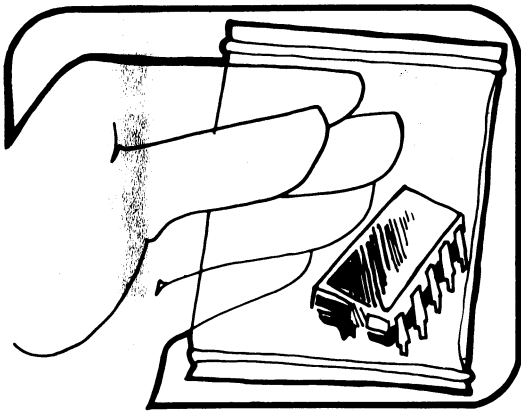

5. USE STATIC SHIELDING CONTAINERS FOR HANDLING AND TRANSPORT

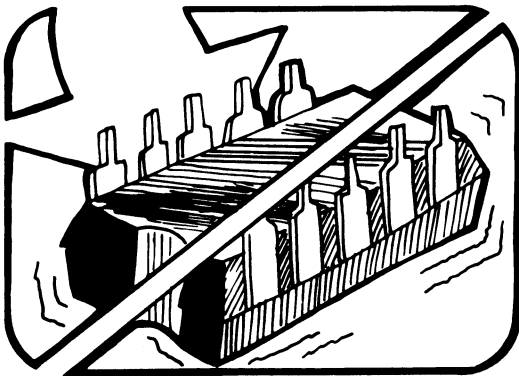

6. DO NOT SLIDE S.S. DEVICES OVER ANY SURFACE

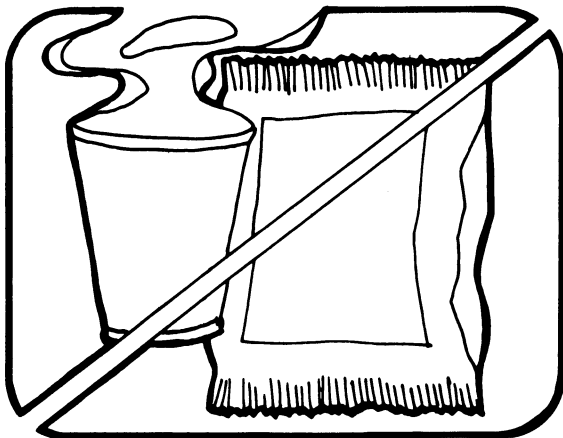

7. AVOID PLASTIC, VINYL AND STYROFOAM® IN WORK AREA

PORTIONS REPRINTED  
WITH PERMISSION FROM TEKTRONIX, INC.  
AND GENERAL DYNAMICS, POMONA DIV.

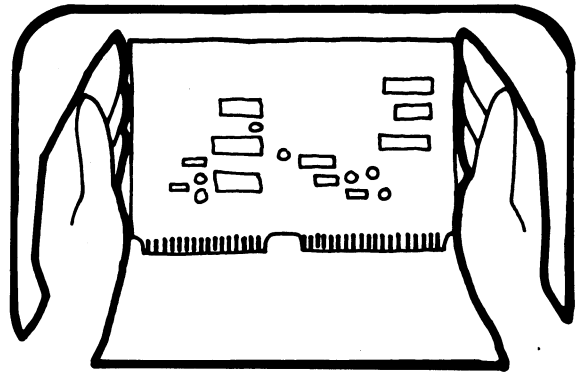

8. WHEN REMOVING PLUG-IN ASSEMBLIES, HANDLE ONLY BY NON-CONDUCTIVE EDGES AND NEVER TOUCH OPEN EDGE CONNECTOR EXCEPT AT STATIC-FREE WORK STATION. PLACING SHORTING STRIPS ON EDGE CONNECTOR HELPS TO PROTECT INSTALLED SS DEVICES.

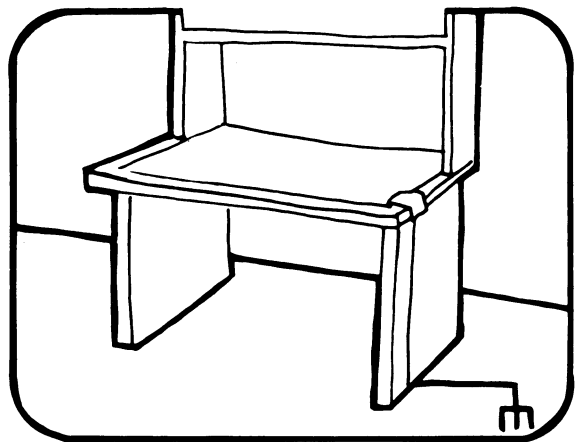

9. HANDLE S.S. DEVICES ONLY AT A STATIC-FREE WORK STATION  
10. ONLY ANTI-STATIC TYPE SOLDER-SUCKERS SHOULD BE USED.  
11. ONLY GROUNDED TIP SOLDERING IRONS SHOULD BE USED.

A complete line of static shielding bags and accessories is available from Fluke Parts Department, Telephone 800-526-4731 or write to:

JOHN FLUKE MFG. CO., INC.  
PARTS DEPT. M/S 86  
9028 EVERGREEN WAY  
EVERETT, WA 98204

---

## Section 2

# Operating Instructions

---

### 2-1. INTRODUCTION

2-2. Although the Model 720A is a primary ratio standard it has the versatility necessary for use in a wide variety of measurement and control applications. In most applications the divider is used as an element of a system for measuring ratios, voltages, or resistances.

### 2-3. POWER LIMITATIONS

2-4. It is possible to damage the Model 720A by applying voltages incorrectly to the input terminals or by drawing more than 11 milliamperes from the output tap. The instrument will be damaged if a potential greater than 200 volts is applied between the 1.0 INPUT terminal and the 1.1 INPUT terminal. To prevent damage caused by drawing excessive current from the output tap, either the input or the output can be fused for 11 milliamperes. Another method of protecting the instrument is through the use of a power supply with current limiting capability. The current limit should be set for 11 milliamperes or less.

### 2-5. FUNCTIONS OF CONTROLS AND TERMINALS

2-6. Figure 2-1 shows the controls and terminals of the Model 720A and describes their functions.

### 2-7. RATIO ERRORS CAUSED BY LOADING OR LEAKAGE

2-8. Measurements of any kind require a knowledge of the errors associated with the equipment used to perform the measurement. Measurement made with the Model 720A are not different.

2-9. One very important source of error in measurements employing the Model 720A is the effect that external load and leakage resistances have on overall accuracy. If excessive current is drawn from the divider output tap because of loading or leakage, linearity errors which far exceed the linearity specifications can result. For this reason, Kelvin-Varley dividers customarily are used in null-balance systems in which minimum current is drawn from the divider output tap.

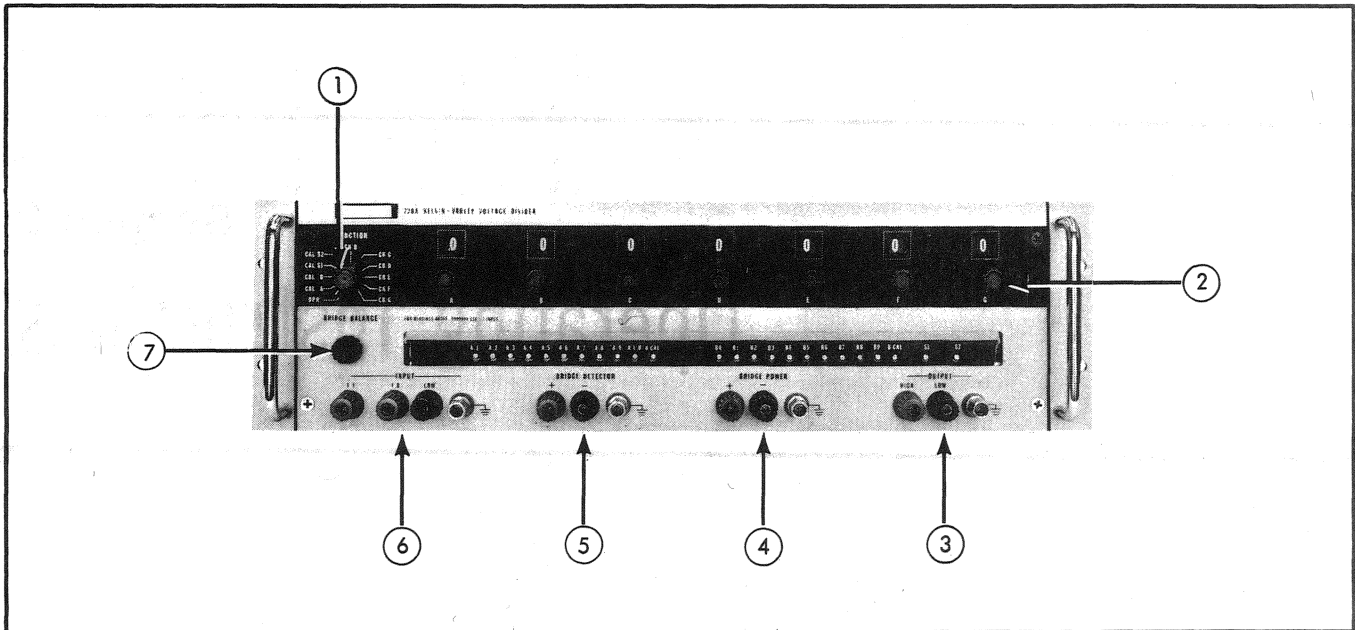

①	<b>FUNCTION SWITCH</b>	Places instrument in operating mode, or performs internal switching for calibration, or performs internal switching for decade linearity test.
②	<b>DIALS</b>	Decade switches are used to set the ratio of output to input (division ratio).
③	<b>OUTPUT TERMINALS</b>	Provide output voltage of the divider. LOW OUTPUT terminal is connected to LOW INPUT terminal through low compensating resistance.
④	<b>BRIDGE POWER TERMINALS</b>	Used to connect the bridge power for calibration. BRIDGE POWER (-) terminal is used for low input during decade linearity testing.
⑤	<b>BRIDGE DETECTOR TERMINALS</b>	Used to connect null detector for calibration.
⑥	<b>INPUT TERMINALS</b>	Used to connect the input voltage across the resistance of the divider.
⑦	<b>BRIDGE BALANCE CONTROL</b>	Used to balance bridge during self-calibration and calibration.

Figure 2-1. FUNCTIONS OF CONTROLS AND TERMINALS

**2-10. Loading Errors**

2-11. Figure 2-2 illustrates the Thevinin equivalent for the Model 720A Kelvin-Varley Divider.

To calculate the error in output voltage, as a fraction of the input voltage, the following expressions are given.

$$E_o (1 + \epsilon_o) = \frac{S(1 + \epsilon) E_{IN} R_L}{R_L + R_o}$$

but  $E_o = SE_{IN}$

therefore  $(1 + \epsilon_o) = \frac{(1 + \epsilon) R_L}{R_L + R_o}$

If  $R_L \gg R_o$  and  $\left(1 + \frac{R_o}{R_L}\right)$  is expanded in series then

$$(1 + \epsilon_o) = (1 + \epsilon) \left[ 1 - \frac{R_o}{R_L} + \left(\frac{R_o}{R_L}\right)^2 - \left(\frac{R_o}{R_L}\right)^3 + \dots \right]$$

$$\approx (1 + \epsilon) \left(1 - \frac{R_o}{R_L}\right)$$

$$\epsilon_o \approx \epsilon - \frac{R_o}{R_L}$$

and  $\epsilon_L \approx \frac{R_o}{R_L}$

Converting to errors expressed as a fraction of the input voltage the expression becomes:

$$\epsilon'_o = \epsilon' - \frac{S R_o}{R_L}$$

If the 1.1 INPUT terminal is used then:

$$E_o = \frac{S}{1.1} E_{IN}$$

and:

$$\epsilon'_o \cong \epsilon' - \frac{S R_o}{1.1 R_L}$$

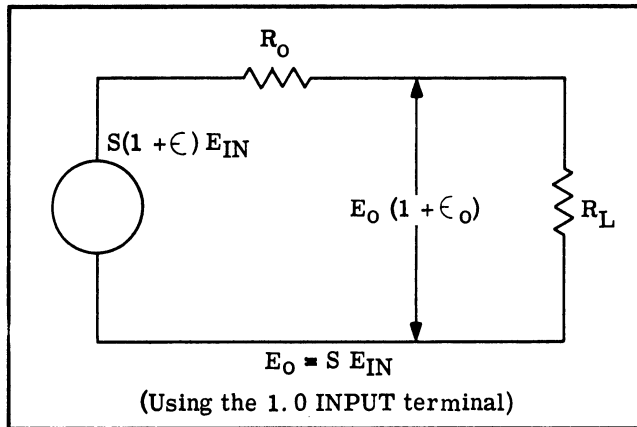

Figure 2-2. THEVININ EQUIVALENT CIRCUIT

2-12. The following list of definitions are given for the terms used in the preceding paragraphs.

- a.  $E_o$  - Nominal output voltage.
- b.  $E_{IN}$  - Input voltage.
- c.  $\epsilon_o$  - Error in output voltage as a fraction of output.
- d.  $\epsilon$  - Divider linearity error as a fraction of output.
- e.  $\epsilon_L$  - Loading error as a fraction of output.
- f.  $\epsilon'_o$  - Error in output voltage as a fraction of input.
- g.  $\epsilon'$  - Divider linearity error as a fraction of input.
- h.  $\epsilon'_L$  - Loading error as a fraction of input.
- i.  $S$  - Divider dial setting.
- j.  $R_o$  - Divider output resistance.
- k.  $R_L$  - Load resistance (including leakage resistance from the tap terminal to the divider input terminal).

## 2-13. Output Resistance Versus Loading

2-14. The graph in Figure 2-3 illustrates the approximate variation of output resistance with the dial setting for both the 1.0 and 1.1 INPUT terminals. This resistance is measured by shorting the input high and input low terminals and measuring the resistance between the output high and low terminals. When computing correction factors for loading of a particular instrument do not use the approximate resistance values given by Figure 2-3. Instead, measure the output resistance at the desired dial setting. The maximum amount of loading which will still be negligible for any dial setting may be calculated as follows:

- a. Divider specification = 0.1 ppm of input.
- b. Maximum loading error limit = 0.03 ppm of input.
- c.  $\frac{S R_o}{R_L} = \epsilon_L = 0.3 \times 10^{-8}$
- d. Maximum  $R_o = 66$  kilohms when  $S = .454$ .
- e. Minimum  $R_L = \frac{S R_o}{\epsilon_L} = \frac{(.454)(6.6 \times 10^4)}{3 \times 10^{-8}} = 1 \times 10^{12}$  ohms.

2-15. Similar calculations have been made for other dial settings and the results have been plotted in Figure 2-4. The choice of a loading error limit of 0.03 ppm was, of course, arbitrary and should vary over a wide range for different measurement applications. In general, the error should be calculated and allowances made unless the errors are small compared to either the desired measurement accuracies or the divider specifications.

2-16. It should be noted that resistances calculated are the parallel combinations of the load resistor and any leakage resistances which may exist from the tap point (OUTPUT HIGH terminal) to the input terminals of the divider.

2-17. In applications where the load resistance must be supplied with a current, this current may be supplied by either a stable power supply or a second voltage divider in parallel with the measurement divider.

## 2-18. TEMPERATURE CONTROL

2-19. Because of slight differences in temperature coefficients of the resistors used in the Model 720A, the linearity of the divider will vary with ambient temperature. This change in linearity will never exceed  $\pm 0.1$  ppm of input per degree centigrade for dial settings above 0.1, and typically will be 0.05 ppm/ $^{\circ}$ C. For measurement applications which require the best possible accuracy, temperature and temperature variations must be considered. The operating temperature should be within  $1^{\circ}$ C of the self-calibration temperature if at all possible. If the desired operating temperature is



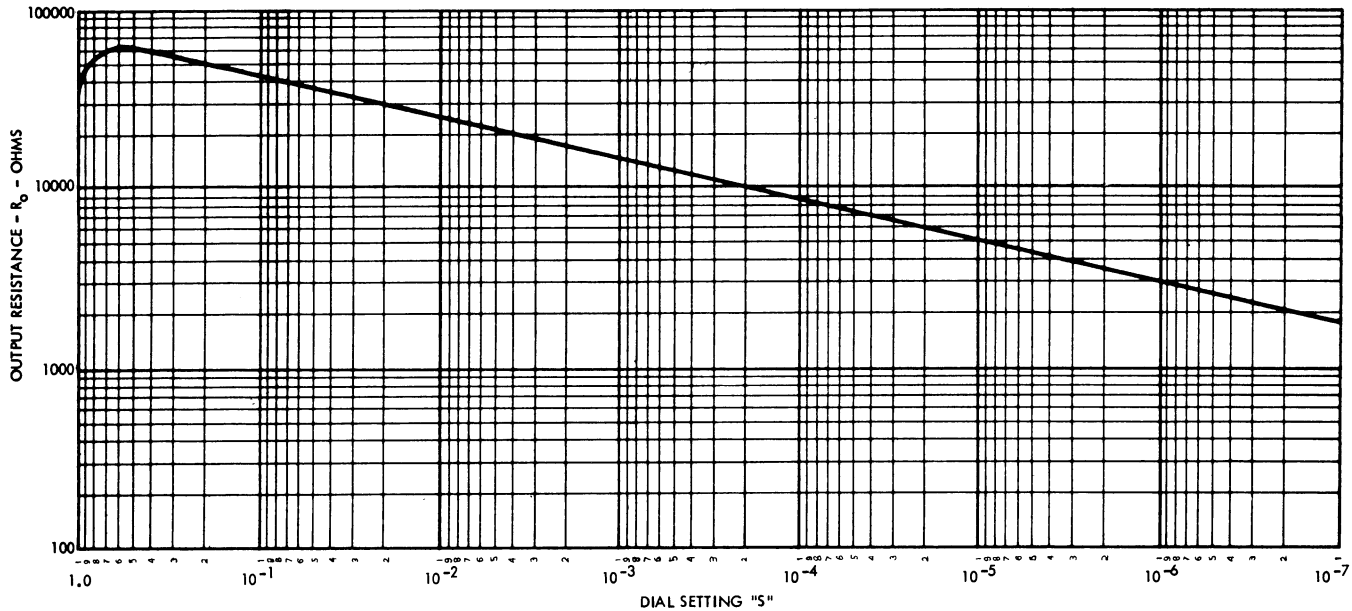

Figure 2-3. APPROXIMATE VARIATION OF OUTPUT RESISTANCE WITH DIAL SETTING

appreciably different from the last calibration temperature, the instrument should be allowed to stabilize at the operating temperature and then the self-calibration procedure should be performed to adjust linearity to 0.1 ppm of input. The Model 720A is factory tested at a temperature of  $23 \pm 1^\circ\text{C}$ .

## 2-20. POWER COEFFICIENT

2-21. The power coefficient will not exceed 0.2 ppm per watt of input power and typically will be 0.1 ppm per watt or less. With high-voltage applied, self-heating will cause the linearity of the instrument to drift. This drift may continue for as long as four hours after application of the high voltage. Low-voltage, high-accuracy measurements (0.1 ppm) should not be attempted immediately after high-voltage use. Each time the setting of the "A" decade is changed, the power distribution in it is changed because the current through the instrument is divided between the two shunted resistors of the "A" decade and the resistance of the other decades which shunts them. Because of this current division, the two shunted resistors do not become as hot as the other resistors in the "A" decade. The change in current distribution brought about by changing the setting of the "A" decade causes linearity to drift for a few minutes if high voltage is applied.

## 2-22. END ERRORS

2-23. When the Model 720A is compared to another divider, and a lead compensator such as the Fluke Model 721A is used, absolute linearity may be used directly without correction for end errors. In other applications, the use of a lead compensator is not practical and end error corrections must be applied. Use the following procedure to determine the end error corrections for the Model 720A:

- a. Connect the equipment as shown in Figure 2-5 (A).
- b. Adjust the input voltage to 1000 volts.
- c. With all dials set to zero, measure the voltage between the OUTPUT HIGH terminal and the INPUT LOW terminal. This is the zero error at input low. One microvolt equals 0.001 ppm.
- d. Connect the equipment shown in Figure 2-5 (B).
- e. Adjust the input voltage to 1000 volts.
- f. With all dials set to zero, measure the voltage between the OUTPUT HIGH and OUTPUT LOW terminals. This is the zero error at output low. One microvolt equals 0.001 ppm.
- g. Connect the equipment as shown in Figure 2-5 (C).
- h. Adjust the input voltage to 1000 volts.
- i. With dials set to 999999X, measure the voltage between the OUTPUT HIGH and 1.0 terminals. This is the full-scale error. One microvolt equals 0.001 ppm.
- j. Maintain the test set up of Figure 2-5 (C) except move the two leads connected to the 1.0 INPUT terminal to the 1.1 INPUT terminal.
- k. Adjust the input voltage to 1000 volts.
1. With all dials set to 1.0 09999X, measure the voltage between the OUTPUT HIGH and 1.1 INPUT terminals. One microvolt equals 0.001 ppm.

## 2-24. SELF-CALIBRATION PROCEDURE

2-25. Performing this self-calibration procedure adjusts the step resistance and overall resistance of the

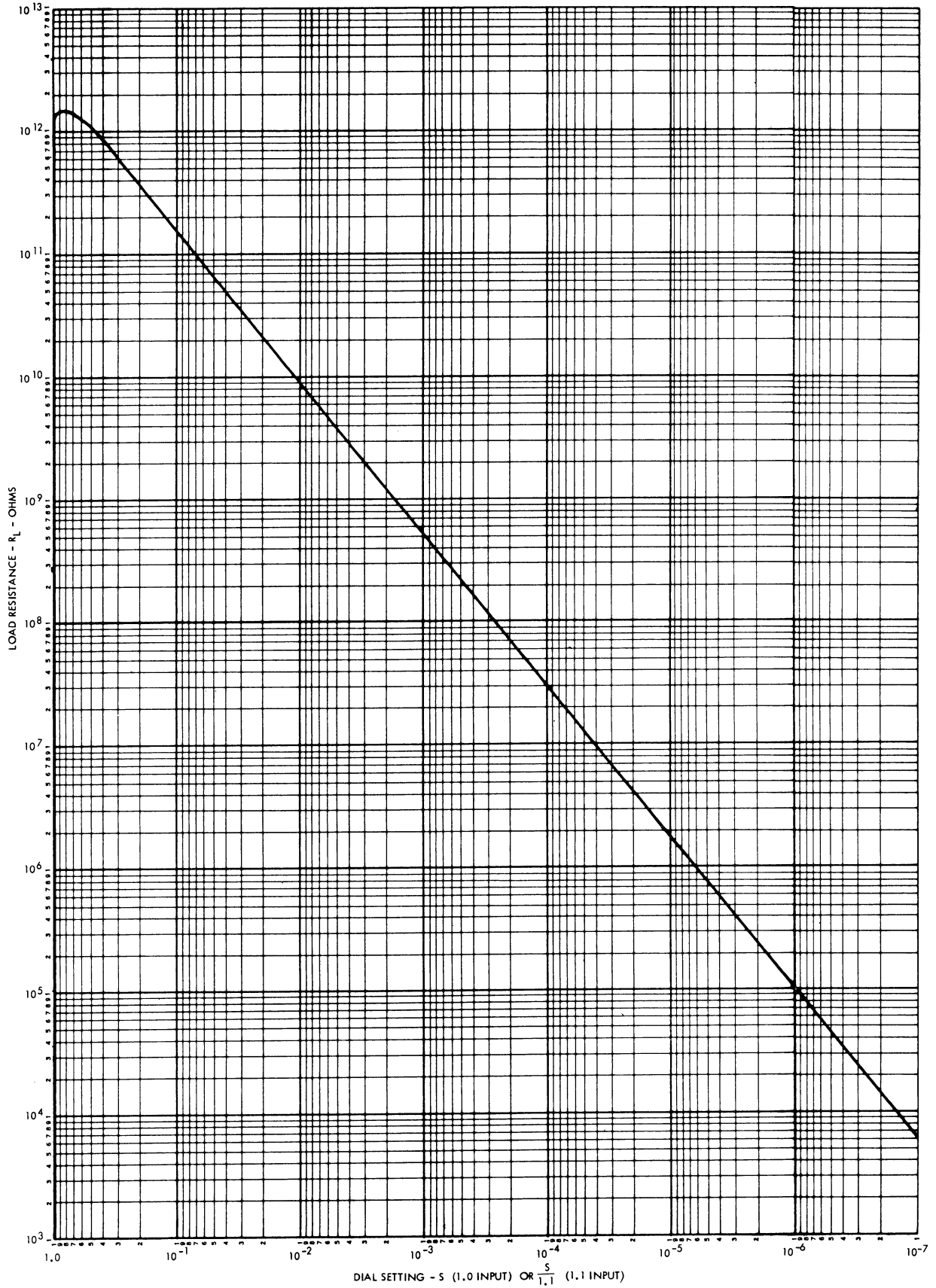

Figure 2-4. APPROXIMATE VARIATION OF MINIMUM LOAD RESISTANCE FOR 0.03 PPM OF INPUT LOADING ERROR

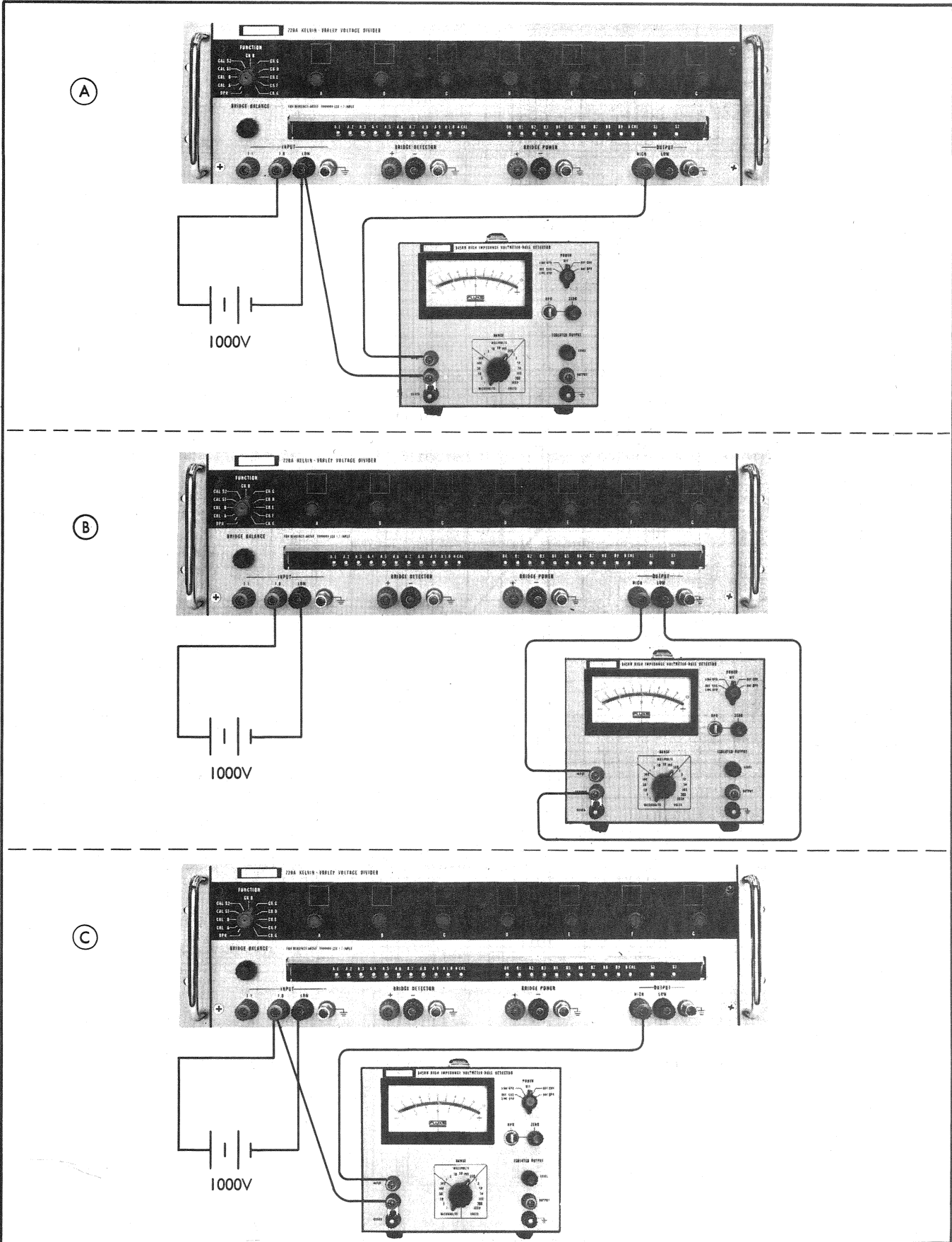

Figure 2-5. CONNECTIONS FOR DETERMINING END ERRORS

first two decades to compensate for any resistance changes caused by temperature changes or aging. Thus, the absolute linearity of the instrument is adjusted to 0.1 ppm of input. The only external test units required are a stable source of 10 volts and 20 volts such as the Fluke Model 412B and a sensitive null detector such as the Fluke Model 845AB. The procedure may be adapted easily to use batteries as the voltage source if a suitable dc power supply is not available. The procedure is as follows:

- a. Connect the null detector (845AB) to the BRIDGE DETECTOR binding posts using low thermal leads.
- b. On the Model 720A, set the FUNCTION switch to CAL A and the decade readout to .000000.
- c. On the Model 845AB, set the range switch to 10 microvolts; set the OPR ZERO switch to ZERO and adjust for zero meter deflection. Return the OPR-ZERO switch to OPR position.
- d. Set the power supply (412B) for 20 volts output and connect it to the BRIDGE POWER binding posts.
- e. Adjust the BRIDGE BALANCE control for a null indication on the Model 845AB.
- f. Advance the "A" decade to 0.1, and adjust the associated variable resistor (A.1) to produce null,  $\pm 0.5$  microvolts.
 

*NOTE!*

*As the procedure is continued, occasionally return the "A" decade switch to zero and recheck bridge balance.*
- g. In turn, advance the "A" decade one position (A.2 through A CAL) and adjust the associated variable resistor.
- h. Return the "A" decade to zero upon completion of the CAL position adjustment.
- i. Set the power supply output to 10 volts.
- j. Adjust the BRIDGE BALANCE to obtain a null.

- k. Set the FUNCTION switch to CAL B, and adjust the associated variable resistor (BO) to produce a null  $\pm 1$  microvolt.

*NOTE!*

*As the procedure is continued, occasionally return the FUNCTION switch to CAL A and recheck bridge balance.*

- l. In turn, advance the "B" decade one position (B1 through B CAL) and adjust the associated variable resistor.
- m. Return the "B" decade to zero upon completion of the CAL position adjustment.
- n. Set the FUNCTION switch to CAL S1 and adjust variable resistor S1 for a null,  $\pm 1$  microvolt.
- o. Set the power supply to 20 volts.
- p. Set the "A" decade to .0 and set the FUNCTION switch to CAL A.
- q. Adjust the BRIDGE BALANCE control for a null.
- r. Set the FUNCTION switch to CAL S2 and adjust variable resistor S2 for a null,  $\pm 0.5$  microvolt.
- s. Set the FUNCTION switch to OPR and disconnect the test units. The self-calibration is complete.

**2-26. CHECK POSITIONS OF THE FUNCTION SWITCH**

2-27. Check positions (CK B etc.) are provided on the FUNCTION switch to permit checking the linearity of each decade from the front panel. This linearity check is a maintenance procedure. It should not be undertaken as a part of operation.

**2-28. APPLICATIONS OF THE MODEL 720A**

2-29. The following paragraphs give general instructions and equipment connections for calibrating a voltage divider, measuring unknown voltages, and measuring unknown resistances. Although these are by no means

TYPICAL EQUIPMENT	REQUIRED SPECIFICATIONS
DC Voltage source; John Fluke Mfg. Co. Model 332B or equivalent.	Output voltage from 0 to 1100 volts. Stability of 0.0015% per hour. Output ripple less than 40 uv rms.
DC Null Detector; John Fluke Mfg. Co. Model 845AB or equivalent.	1 uv full-scale sensitivity. 10 megohms input resistance.
Lead compensator; John Fluke Mfg. Co. Model 721A	Resolution of 0.1 milliohm.

Figure 2-6. TYPICAL ASSOCIATED EQUIPMENT FOR VOLTAGE DIVIDER CALIBRATION

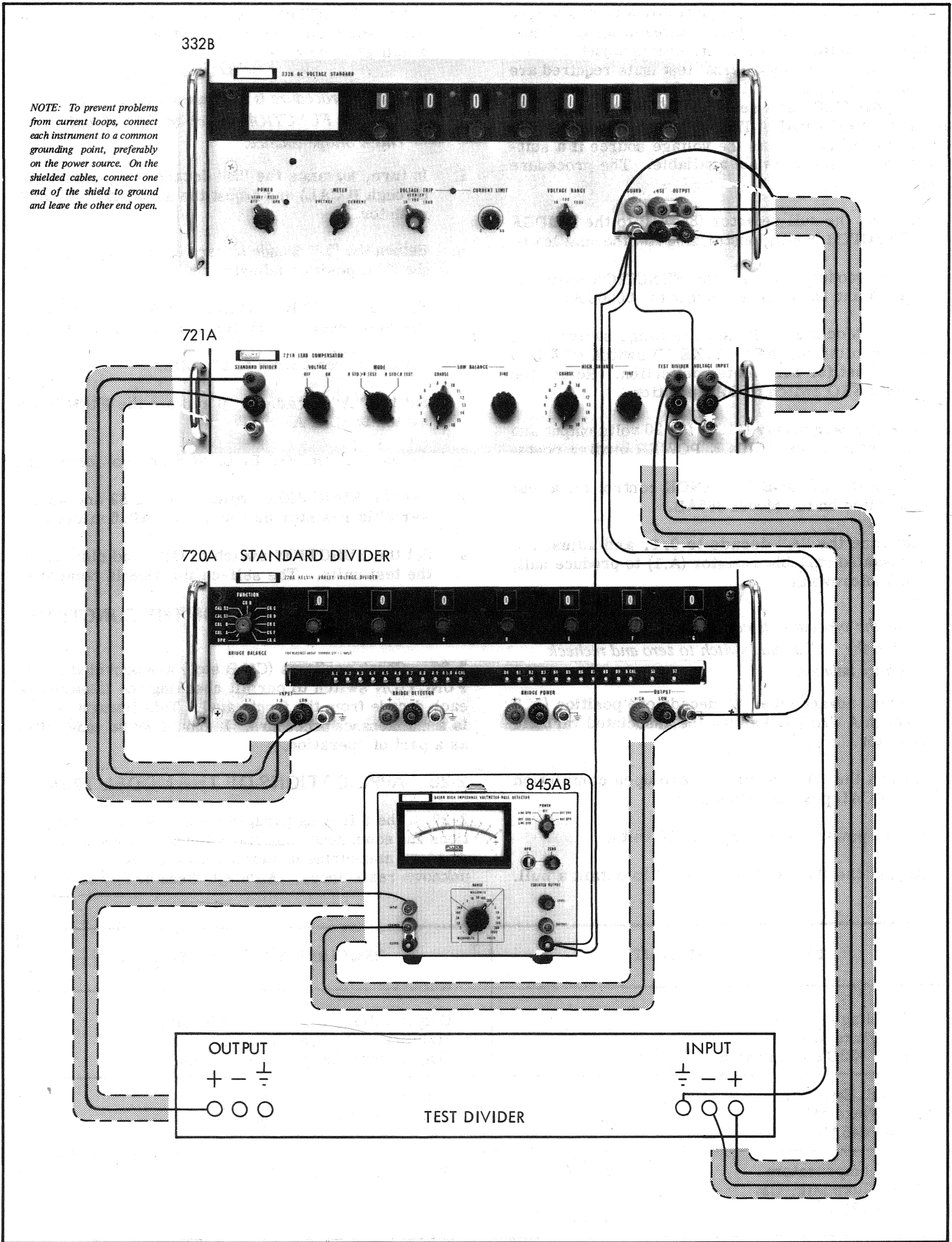

Figure 2-7. EQUIPMENT CONNECTIONS FOR CALIBRATING A VOLTAGE DIVIDER

the only applications of the instrument, they are the most common applications of a high-accuracy Kelvin-Varley divider such as the Model 720A.

### 2-30. Calibrating a Voltage Divider

2-31. The Model 720A in company with a dc voltage source, a null detector, and a lead compensator can be used to calibrate voltage dividers to an accuracy of 0.1 parts per million of input. Typical associated equipment for this application is listed in Figure 2-6. With this equipment, the full electrical capabilities of the Model 720A Kelvin-Varley Voltage Divider may be realized.

2-32. To calibrate a voltage divider, connect the equipment as shown in Figure 2-7 and proceed as follows:

#### NOTE!

Figure 2-8 is a schematic diagram of the test setup obtained by interconnecting the equipment as shown in Figure 2-7.

- a. Set both dividers to zero.
- b. Turn all equipment on and allow it to warm up until it reaches temperature equilibrium.
- c. Place the null detector in zero mode, adjust it for zero deflection, and return it to operating mode.
- d. Adjust the LOW BALANCE controls of the lead compensator to obtain a zero indication on the null detector.
- e. Turn the HIGH BALANCE COARSE control to the same setting as the LOW BALANCE COARSE control.
- f. Set both dividers to full scale and adjust the HIGH BALANCE FINE control to obtain a zero indication on the null detector.
- g. Set both dividers to zero and re-adjust the LOW BALANCE FINE control if necessary to obtain a zero indication on the null detector.
- h. Set both dividers to the first calibration point.
- i. Observe the null detector and adjust the Model 720A to obtain a zero indication on the null detector. The difference between the setting of the Model 720A and the nominal value of the calibration point is the error of the divider being calibrated expressed as a decimal fraction of the input.
- j. Find the error at each calibration point until the calibration is complete.

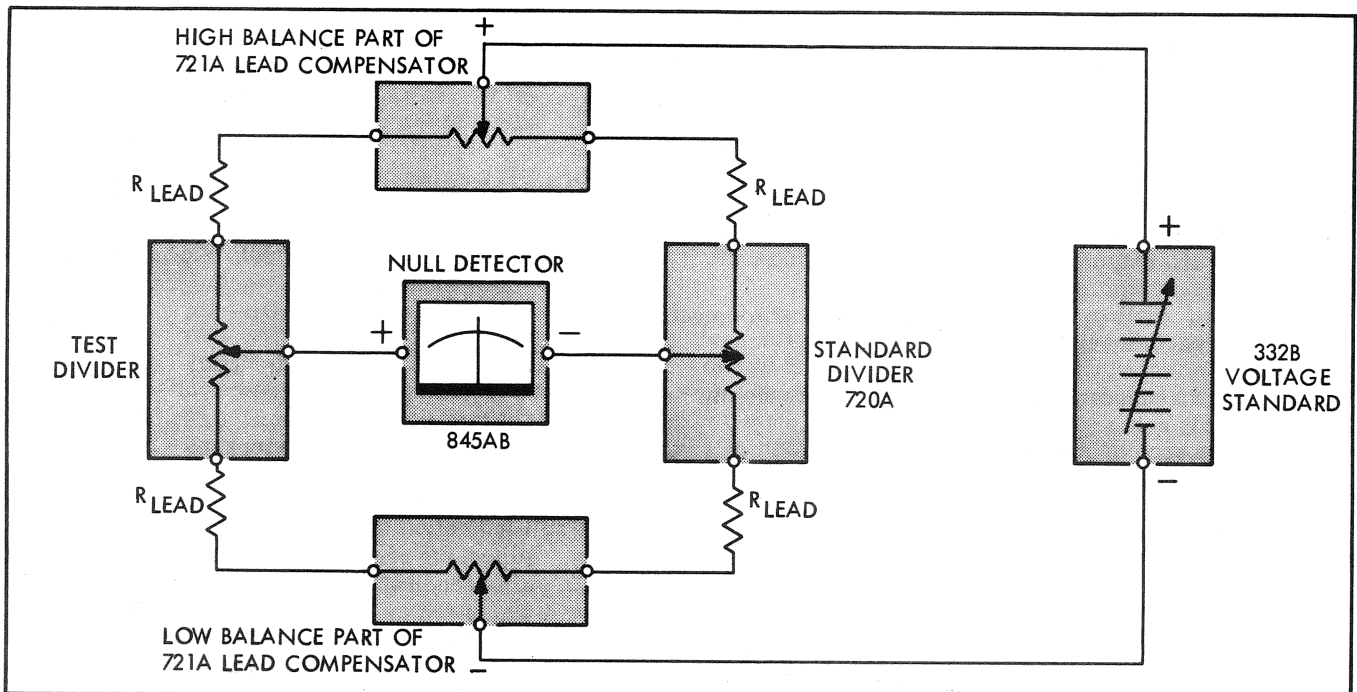

Figure 2-8. SIMPLIFIED SCHEMATIC DIAGRAM OF VOLTAGE DIVIDER CALIBRATION

TYPICAL EQUIPMENT	REQUIRED SPECIFICATIONS
DC Voltage Source; John Fluke Mfg. Co. Model 332B or equivalent.	Output voltage from 0 to 1100 volts. Stability of 0.0015% per hour. Output ripple less than 40 uv rms.
DC Null Detector (2 required); John Fluke Mfg. Co. Model 845AB or equivalent.	1 uv full-scale sensitivity. 10 megohms input resistance.
Standard Cell; Guildline Instruments Model 9152 or equivalent.	At least three saturated cells. Accuracy of 0.0005%.
DC Reference Voltage Divider; John Fluke Mfg. Co. Model 750A or equivalent.	Output accuracy of $\pm 10$ ppm. Input and output voltage. Rating of 1100V dc.

Figure 2-9. TYPICAL ASSOCIATED EQUIPMENT FOR MEASURING UNKNOWN VOLTAGES

### 2-33. Measuring Unknown Voltages

2-34. The Model 720A in company with a stable dc voltage source, two null detectors, a standard cell, and a reference voltage divider may be used to measure an unknown voltage with high accuracy. Typical equipment for this application is listed in Figure 2-9. With this equipment the full electrical capabilities of the Model 720A may be realized.

2-35. To measure an unknown voltage, first connect the equipment as shown in Figure 2-10. The size of wire for leads A and B should be no smaller than No. 24 and the total length should be less than 3 feet. Then measure the approximate voltage by dialing the Model 720A to .000000 and reading the null detector on the appropriate voltage range. Proceed as follows:

- a. Open the standard cell voltage switch on the reference divider and set the standard cell voltage dials to the correct standard cell voltage.
- b. Set the reference divider input switch to the first position higher than the voltage to be measured. Set the output switch to the same position.
- c. Turn on all equipment and allow it to warm up until it reaches temperature equilibrium.
- d. Set the standard cell switch of the reference divider to momentary position and adjust the output of the dc source to obtain a null indication on null detector number 1.
- e. Adjust the readout dials of the Model 720A to obtain a null indication on null detector number 2.
- f. Calculate the unknown voltage by multiplying the input voltage of the Model 720A by the numerical setting of the readout dials. For example, if the input voltage is 100 volts and the dial setting is .8903174, the unknown voltage is 89.03174 volts.

### 2-36. Simplified Method of Voltage Measurement

2-37. Voltages under 11 volts may be measured with comparable accuracy by the simpler equipment setup shown in Figure 2-12. This method standardizes the output voltage of the Model 720A by comparing it directly to a known standard cell. When used with an input of 1.1 volts, it is ideally suited to the accurate certification of standard cells. Typical associated equipment for this application is listed in Figure 2-11.

2-38. To measure the unknown voltages, connect the equipment as shown in Figure 2-12 and proceed as follows:

- a. Set the dc voltage source for an output of eleven or 1.1 volts depending on the desired range and allow to warm up.
- b. Set the readout dials of the Model 720A to the standard cell voltage.
- c. Connect the standard cell in place of the unknown voltage and adjust the dc source to obtain a null indication on the null detector.
- d. Disconnect the standard cell.
- e. Set the readout dials of the Model 720A to the approximate value of the unknown voltage.
- f. Connect the unknown voltage.
- g. Adjust the readout dials of the Model 720A to obtain a null indication on the null detector.
- h. Calculate the unknown voltage by multiplying by 10 or 1 depending on the range. For example, if the readout dials are set at .7500055 and the input is 11 volts, the unknown voltage is 7.500055 volts.

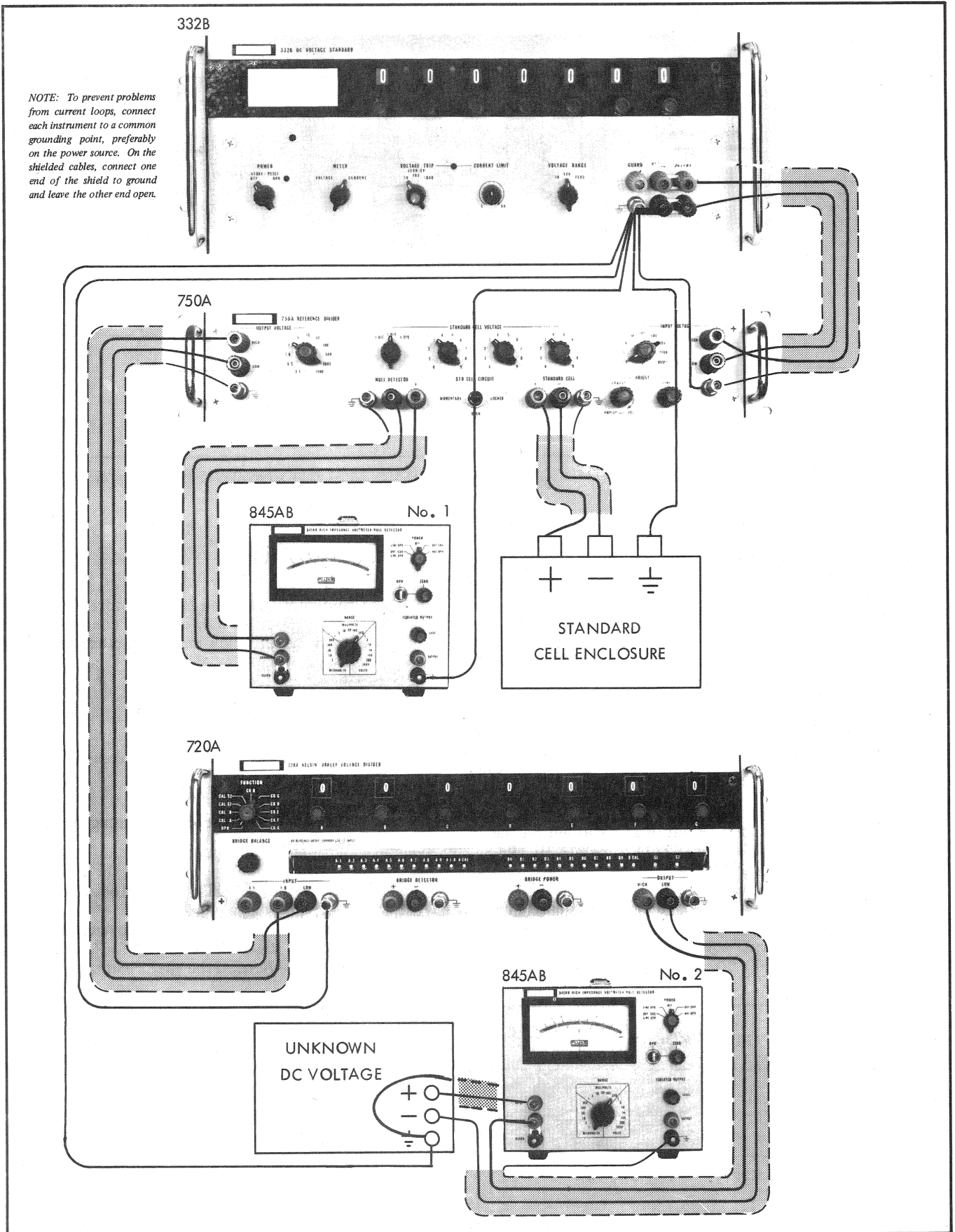

Figure 2-10. EQUIPMENT CONNECTIONS FOR VOLTAGE MEASUREMENTS (Sheet 1 of 2)



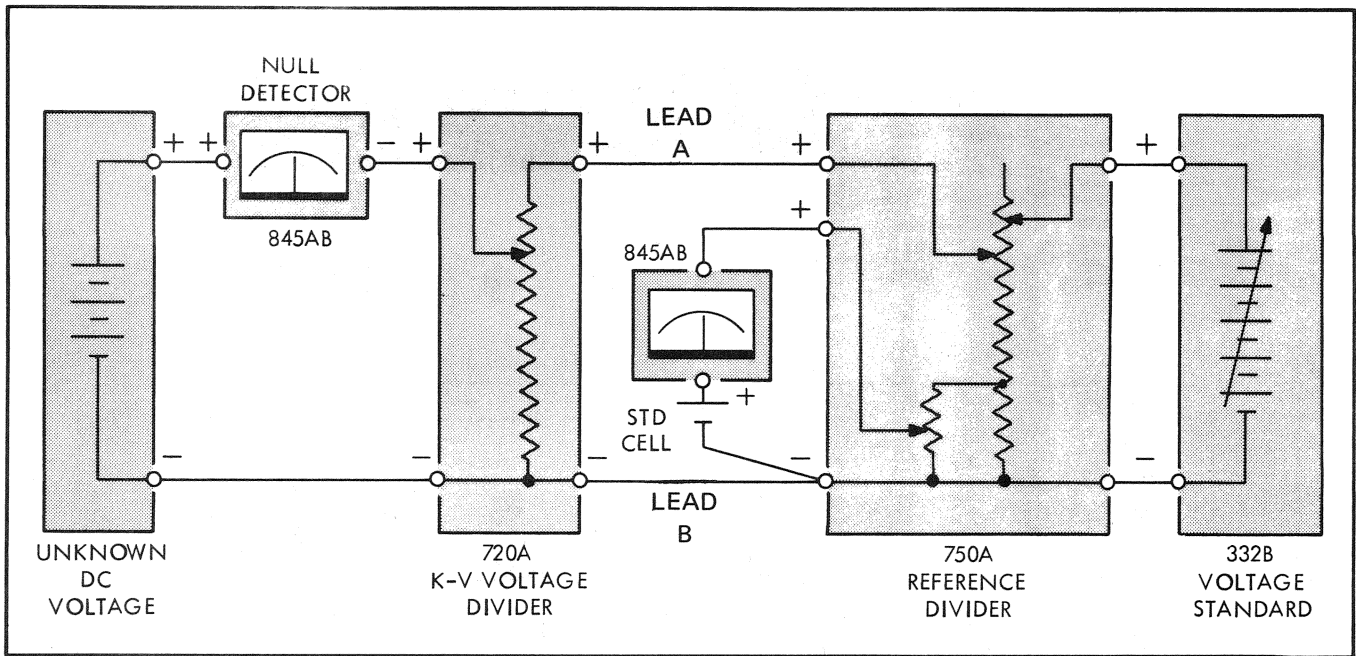

Figure 2-10. EQUIPMENT CONNECTIONS FOR VOLTAGE MEASUREMENTS (Sheet 2 of 2)

**2-39. Measuring Unknown Resistance**

2-40. The Model 720A may be used in a setup including a null detector, a power supply, and a standard resistor, to measure an unknown resistance with a high degree of accuracy. Typical associated equipment for this application is listed in Figure 2-13. The unknown resistance and the standard resistance should be in the same order of magnitude for the best accuracy.

2-41. To measure an unknown resistance, connect the equipment as shown in Figure 2-14 using shielded leads. Apply the positive lead from the dc voltage source to the 1.0 INPUT terminal of the Model 720A. Proceed as follows:

$P_1$ ,  $P_2$ ,  $P_3$ , and  $P_4$  = decimal ratio set on the readout dials of the Model 720A at points  $P_1$ ,  $P_2$ ,  $P_3$ , and  $P_4$  respectively.

If  $R_x + R_{std}$  is greater than 100 ohms, the use of a lead compensator is desirable. If a lead compensator is used,  $P_1$  can be made equal to 1.0000000 and  $P_4$  can be made equal to .0000000.

$$\frac{R_x}{R_{std}} = \frac{1 - P_2}{P_3}$$

If lead resistance between the resistors is made insignificant in addition to using a lead compensator, then  $P_2 = P_3$  and the equation may be further simplified to:

$$\frac{R_x}{R_{std}} = \frac{1}{P} - 1$$

- a. Set the dc voltage source to the desired test voltage.

**CAUTION!**

**Do not exceed the current rating of the standard resistor.**

- b. Set the readout dials of the Model 720A to zero.
- c. Connect the null detector lead to point  $P_1$  and adjust the readout dials of the Model 720A to obtain a null indication. Record the dial reading.

TYPICAL EQUIPMENT	REQUIRED SPECIFICATIONS
DC Voltage Source; John Fluke Mfg. Co. Model 332B or equivalent.	Output voltage from 0 to 1100 volts. Stability of 0.0015% per hour. Output ripple less than 40 uv rms.
DC Null Detector John Fluke Mfg. Co. Model 845AB or equivalent.	1 uv full-scale sensitivity. 10 megohms input resistance.

Figure 2-11. TYPICAL ASSOCIATED EQUIPMENT FOR MEASURING UNKNOWN VOLTAGES

*NOTE To prevent problems from current loops, connect each instrument to a common grounding point, preferably on the power source. On the shielded cables, connect one end of the shield to ground and leave the other end open.*

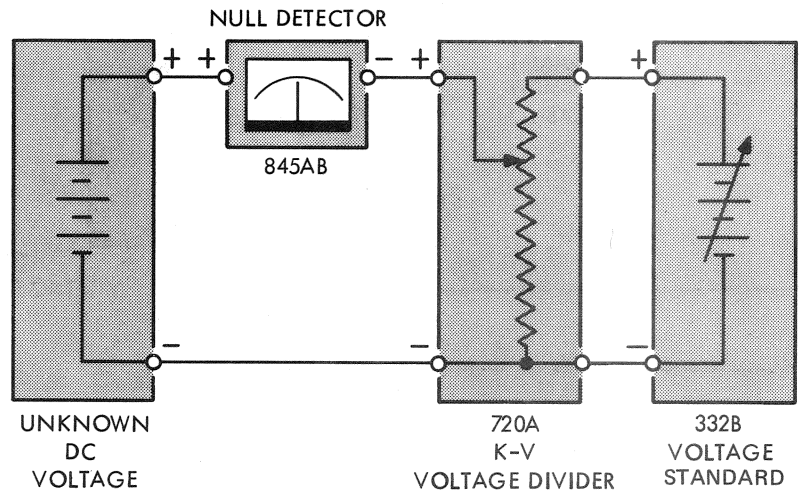
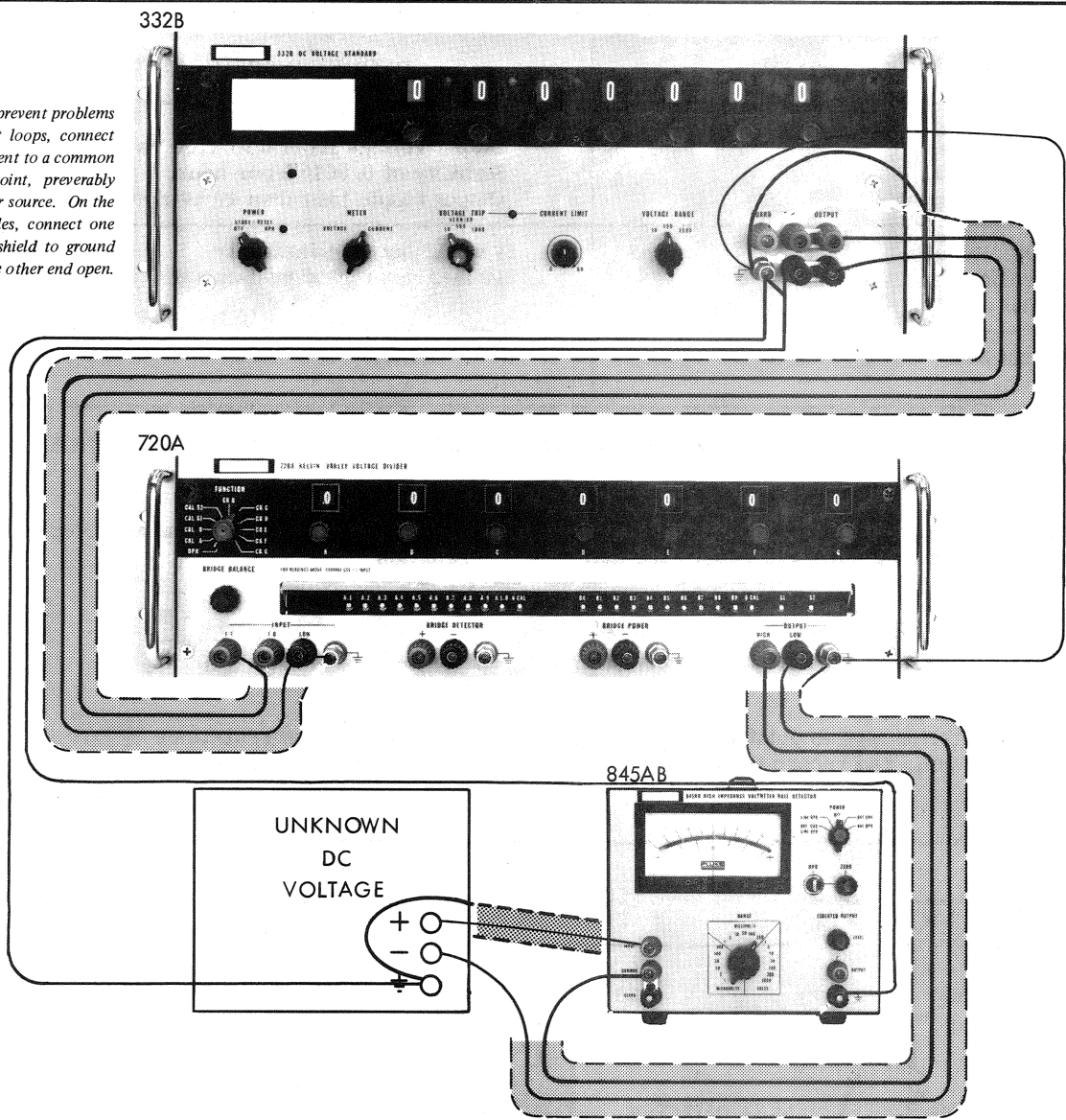

Figure 2-12. EQUIPMENT CONNECTIONS FOR SIMPLIFIED METHOD OF VOLTAGE MEASUREMENT

TYPICAL EQUIPMENT	REQUIRED SPECIFICATIONS
DC Voltage Source; John Fluke Mfg. Co. Model 332B or equivalent.	Output voltage from 0 to 1100 volts. Stability of 0.0015% per hour. Output ripple less than 40 uv rms.
DC Null Detector John Fluke Mfg. Co. Model 845AB or equivalent.	1 uv full-scale sensitivity. 10 megohms input resistance.
Standard resistor.	

Figure 2-13. TYPICAL ASSOCIATED EQUIPMENT FOR MEASURING UNKNOWN RESISTANCE RATIOS

- d. Move the null detector lead to point P<sub>2</sub>, adjust the readout dials to obtain a null, and record the dial reading.
- e. Move the null detector lead to point P<sub>3</sub>, adjust the readout dials to obtain a null, and record the reading.
- f. Move the null detector lead to point P<sub>4</sub>, adjust the dials to obtain a null, and record the dial reading.
- g. Calculate the unknown resistance from the following equation.

$$\frac{R_x}{R_{std}} = \frac{P_1 - P_2}{P_3 - P_4}$$

where:

R<sub>x</sub> = unknown resistance  
R<sub>std</sub> = standard resistance

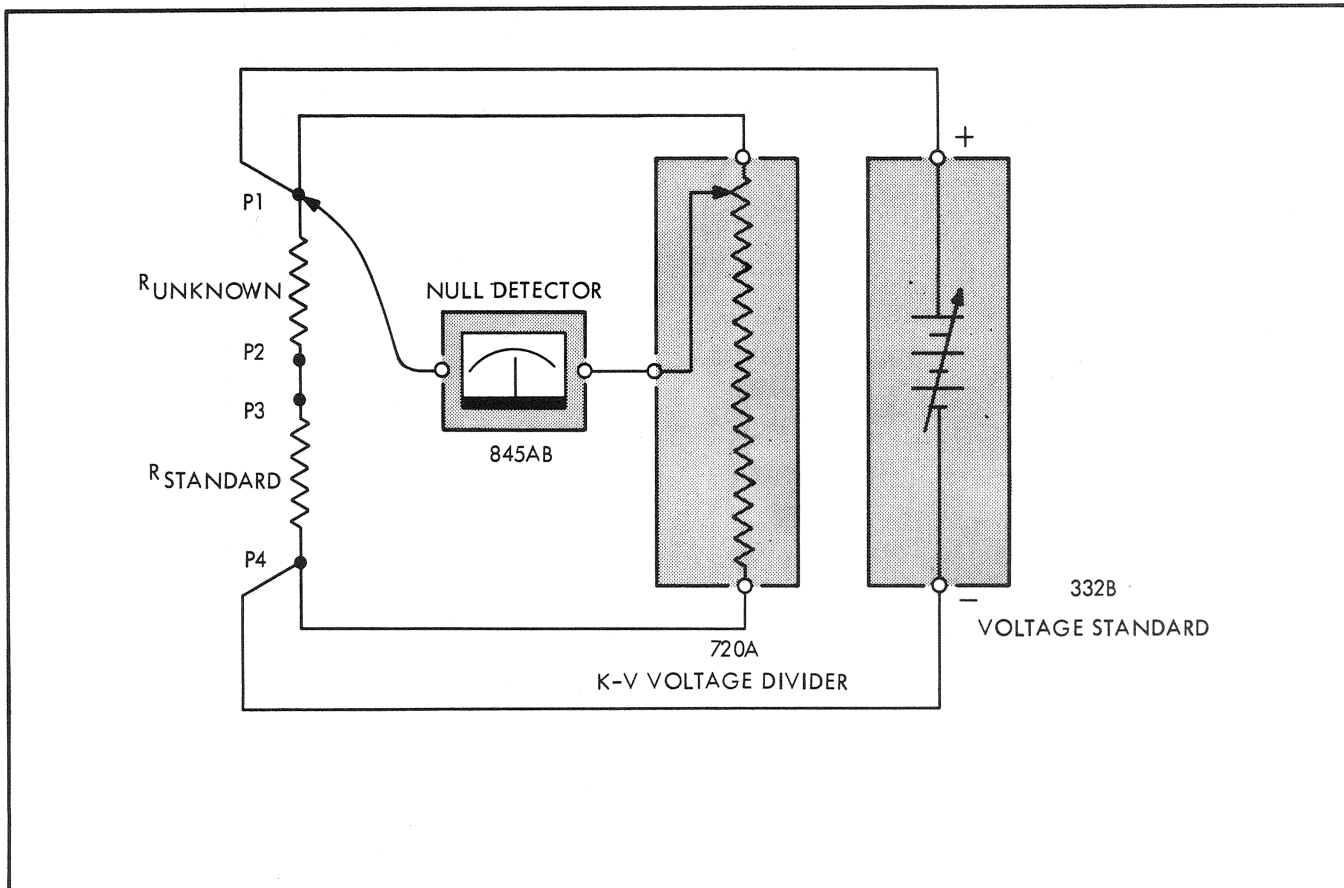

Figure 2-14. EQUIPMENT CONNECTIONS FOR DETERMINING AN UNKNOWN RESISTANCE VALUE (Sheet 1 of 2)

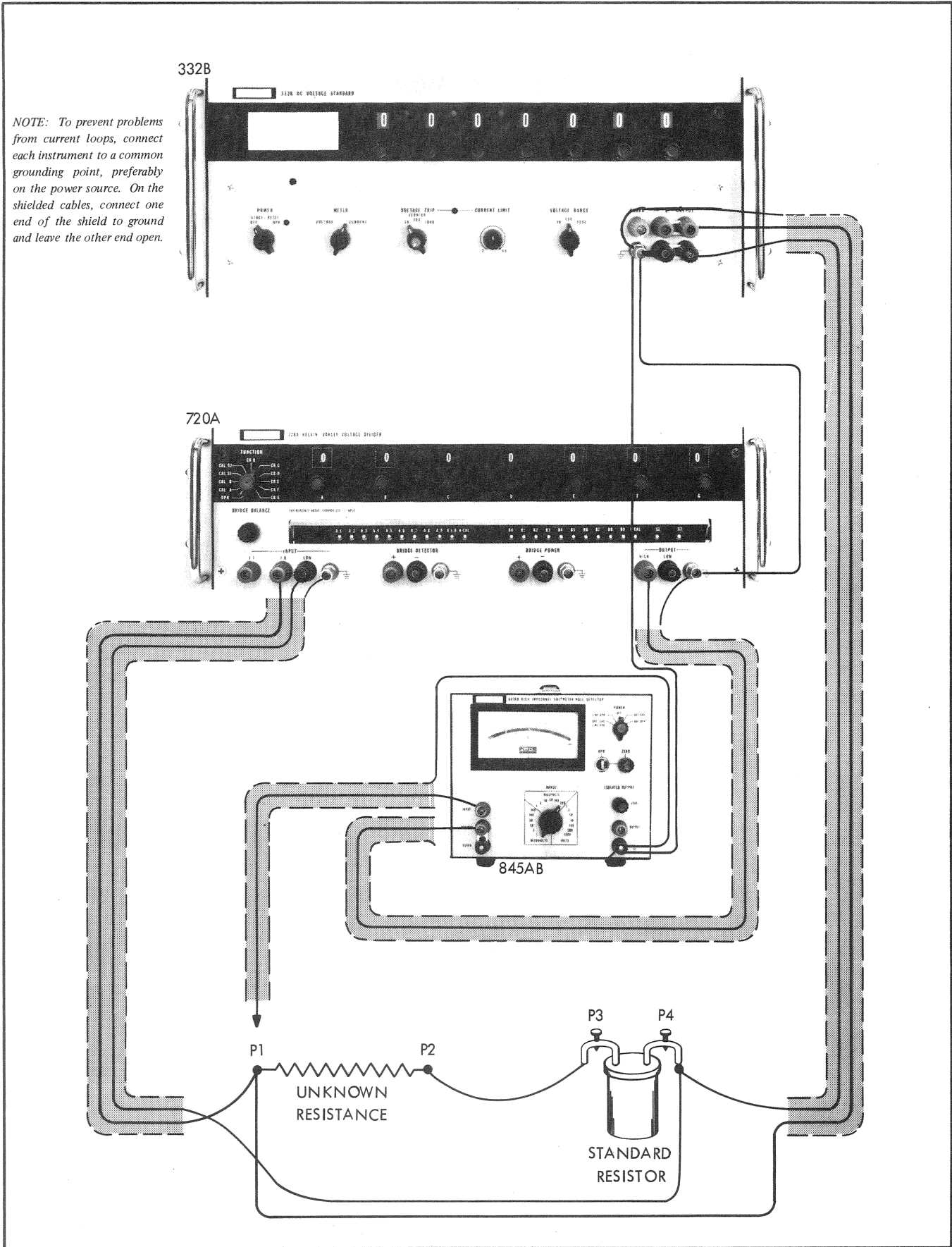

Figure 2-14. EQUIPMENT CONNECTIONS FOR DETERMINING AN UNKNOWN RESISTANCE VALUE (Sheet 2 of 2)

## Section 3

## Theory of Operation

**3-1. INTRODUCTION**

3-2. The Kelvin-Varley divider is a resistive circuit used primarily as a ratio standard. It is capable of dividing the input voltage with high resolution, usually to six or seven decimal places, and with high accuracy, usually a few parts per million.

**3-3. THE BASIC CIRCUIT**

3-4. Figure 3-1 is a simplified schematic diagram of a basic Kelvin-Varley divider. This simplified divider is capable of dividing the input voltage into 10,000 parts. It consists of four decades or resistive dividers each of which divides its input voltage into 10 equal parts ( $10^4 = 10,000$ ).

3-5. For a decade to divide the voltage across it into 10 equal parts it must consist of 10 equal resistances. Placing the resistance of succeeding decade in parallel with a portion of the resistance of a decade, reduces the effective resistance of that portion. Referring to Figure 3-1, notice that the shunted resistance in the first decade is 20 kilohms and that each of the other steps is 10 kilohms. The 20 kilohms in the first decade is shunted by the 20 kilohms total effective resistance of the second decade resulting in a total effective resistance of 10 kilohms for that step. Thus all steps are kept equal. Each step of the second decade is two kilohms. The four kilohms spanned by the switch contacts is shunted by the four kilohms effective resistance of the third decade. Similarly 800 ohms of the third decade is shunted by the 800 ohms total resistance of the fourth decade.

**3-6. CIRCUIT REFINEMENTS**

3-7. Although the simplified Kelvin-Varley divider shown in Figure 3-1 shows all of the essential details of the basic circuit, a number of common design refinements should be mentioned. The latter decades may employ step resistors which are all of the same value and a shunt across the entire decade to reduce the effective decade resistance to the proper value. In Figure 3-1, this could be accomplished by using 400 ohm resistors in the fourth decade with a 1000 ohm shunt across the decade to reduce the effective resistance of

the decade to 800 ohms. This avoids the necessity of using resistors of very small value in the latter decades. Usually each step of at least the first decade will consist of two equal resistors matched for equal but opposite temperature coefficients. This matching tends to produce a zero temperature coefficient for each step and for the entire decade, which reduces the nonlinearity caused by uneven temperature when power is applied. Some Kelvin-Varley dividers have adjustable trimmer resistors in the first, or even the second and third decades to permit compensation for drift and changes of ambient temperature. Overranging capability is provided in some circuits by adding an additional step of resistance and a 1.1 input terminal at the upper end of the first decade. In some dividers a small series resistance is added between the lower end of the divider string and the low input terminal to compensate for contact and wiring resistance bringing the low output voltage at zero setting to the same value as the low input voltage. Although these refinements improve the capability of the circuit, it operates in the same manner with them as without them.

**3-8. THE MODEL 720A**

3-9. The Model 720A is a seven-dial Kelvin-Varley divider with overranging and adjustable trimmers in the first three decades. The low output is compensated by a small resistance in series with the low input terminal. The input resistance (total effective resistance of the first decade is 110 kilohms at the 1.1 input terminal or 100 kilohms at the 1.0 input terminal. Resistors of equal value and fixed decade shunts are used in the last four decades to avoid using very small resistance values.

3-10. Design characteristics of the Model 720A which are not commonly found in Kelvin-Varley dividers include adjustable shunts in the first three decades, a built-in Wheatstone bridge, and switching to permit linearity adjustment (self-calibration) from the front panel. In addition, internal switching provides access to the second through the seventh decades so the linearity of any decade may be checked against a 10-step divider from the front panel.

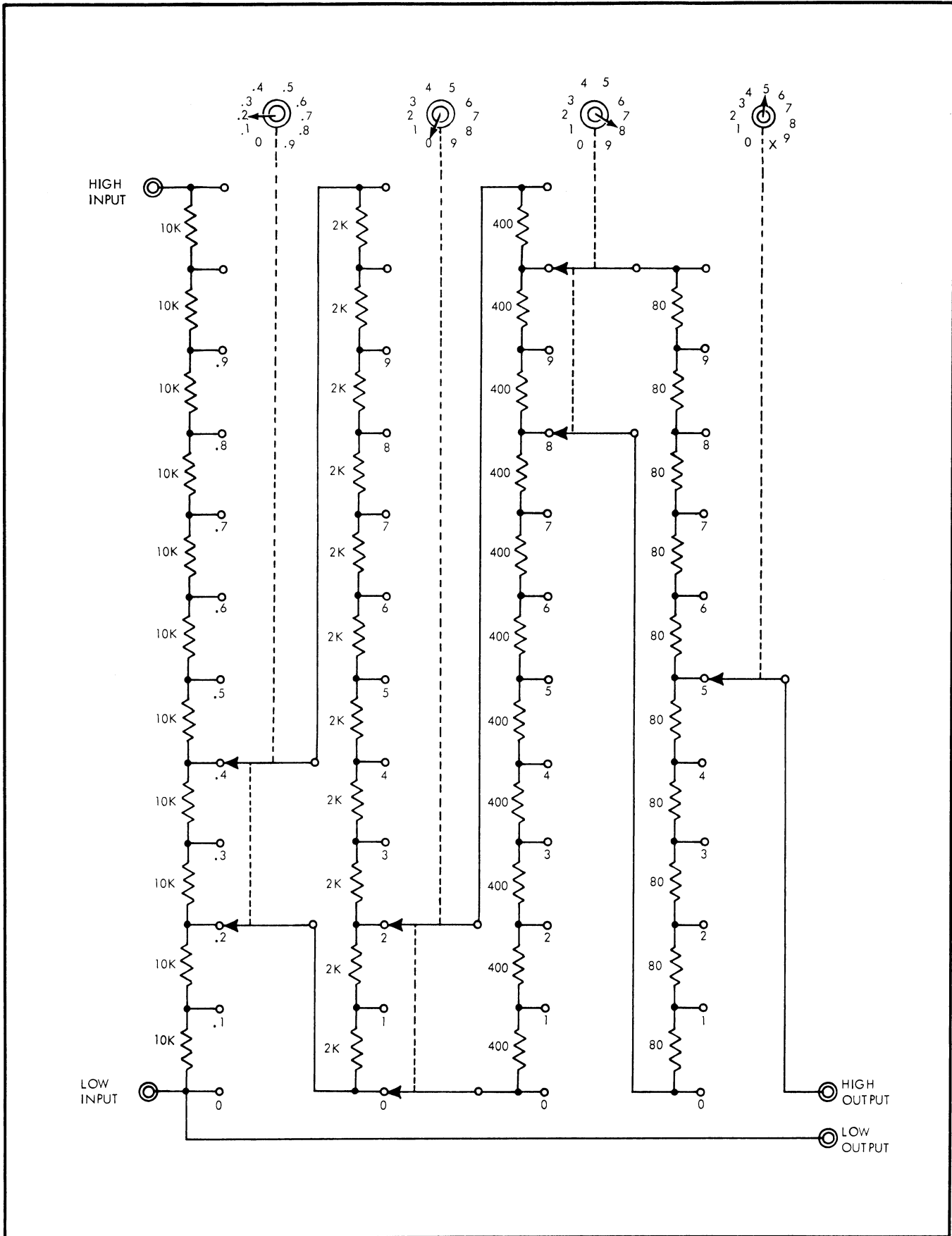

Figure 3-1. SIMPLIFIED SCHEMATIC DIAGRAM OF BASIC KELVIN-VARLEY DIVIDER CIRCUIT

---

## Section 4

# Maintenance

---

### 4-1. INTRODUCTION

4-2. This section contains the instructions and information required for maintenance of the Model 720A Kelvin–Varley Divider. Instructions are included for preventive maintenance, testing and repair of the instrument. If repair is beyond the capability of the user, it is recommended that the instrument be returned to the manufacturer. All maintenance procedures except the replacement of factory selected resistors and resistors housed in the oil tank are within the capability of a skilled technician if the listed test equipment is available.

4-3. The ratio accuracy of 0.1 ppm of the Model 720A is guaranteed for one year after shipment from the factory provided the instrument is regularly self-calibrated in accordance with paragraph 2-24 and is operated in the same environment in which it is self-calibrated. The instrument also must meet the requirements of the Leakage Resistance Test, paragraph 4-8. In the self-calibration procedure, all resistors on the A and B decades are adjusted to be equal to each other by substituting each in turn into the self-contained resistance bridge. The Linearity Test given in paragraph 4-14 should be performed once each year to verify instrument performance. If testing and calibration are beyond the capability of the user, these services may be obtained from a commercial calibration laboratory or from the manufacturer.

### 4-4. TEST EQUIPMENT REQUIRED FOR MAINTENANCE

4-5. The test equipment required for maintenance is listed in Figure 4-1. Equivalent or similar units may be substituted for those listed providing they have the required specifications listed in the figure.

### 4-6. PREVENTIVE MAINTENANCE

4-7. Preventive maintenance of the Model 720A consists of leakage resistance testing, cleaning, switch contact lubrication, and linearity testing. The frequency with which preventive maintenance procedures should be scheduled depends upon the user's requirements and the environment of the instrument. In an air conditioned standards laboratory, there will be little contamination of surfaces within this instrument and therefore testing and cleaning will seldom be required. In a contaminated atmosphere, frequent testing and cleaning may be required to maintain the accuracy of the instrument.

### 4-8. Leakage Resistance Tests

4-9. The need for cleaning can be determined without removing the cover from the Model 720A by performing

RECOMMENDED EQUIPMENT	SPECIFICATIONS REQUIRED
DC Voltage Source John Fluke Mfg. Co. Model 332B or Model 412B	Source of 0 to 1100 vdc. Accuracy at least 0.25% Stability at least 0.005% per hour.
DC Null Detector John Fluke Mfg. Co. Model 845AB	Sensitivity at least 10 microvolts full scale. 10 Megohm input Resistance.
Lead Compensator John Fluke Mfg. Co. Model 721A	Resolution of 0.1 milliohm. Ratio capability of 110:1
Standard Divider John Fluke Mfg. Co. Model 720A	Ratio accuracy of 0.1 ppm of input.
Standard Divider (11 Steps)	Ratio accuracy of 0.05 ppm of input
Decade Resistance Standard Electro Scientific Industries Model RS925A	4007.6 ohms, 10,000 ohms Accuracy of $\pm 20$ ppm

Figure 4-1. TEST EQUIPMENT REQUIRED FOR MAINTENANCE

the simple leakage resistance test described in this paragraph. This test should also be performed after cleaning to assure that all contamination has been removed. To measure leakage resistance, proceed as follows:

- a. Place the Model 720A on a sheet of dielectric.
- b. Use teflon insulated wire to connect the Model 720A, a 1000-volt source (Model 332B), and a null detector (Model 845AB) as shown in Figure 4-2.
- c. Connect a shunt resistor across the input of the null-detector to bring its input resistance to one megohm on the one millivolt range. The value required for the Model 845AB is 1.1 megohms.
- d. Turn on the 1000-volt supply and read the null detector. An indication of 1 millivolt corresponds to leakage resistance of  $10^{12}$  ohms. If the indication is more than 1 millivolt, the leakage resistance is too low and corrective measures must be taken. If repeated cleaning fails to correct the problem, troubleshooting must be undertaken.

#### 4-10. CLEANING

- 4-11. When the Model 720A is properly cared for and

kept in a controlled atmosphere, cleaning will seldom be required. However, any contamination, particularly oil, in the instrument can contribute to reduced leakage resistance which will impair accuracy. Special care has been taken in the design and manufacture of the instrument to prevent leakage. The voltage dial switches are supported by Lexan spacers, and the circuit board is coated with a moisture sealant and isolated from the chassis by polyethylene grommets. These insulators and the switches can be contaminated easily by handling or by airborne contaminants. Dust may be removed with dry oil-free air at a pressure of 15 pounds per square inch or less. To remove oil, place the instrument on its side, place paper towels under it and spray with denatured anhydrous ethyl alcohol, Crown SPRA-TOOL No. 8011 or equivalent. When dry, perform switch contact lubrication, paragraph 4-12. After cleaning and drying, the leakage resistance test should be performed to assure that the excessive leakage has been corrected.

#### 4-12. Switch Contact Lubrication

- 4-13. Corrosion of switch contacts can cause high contact resistance in one or more positions resulting in an impairment of linearity. If evidence of this condition is present and exercising the switch fails to correct it, the switch contact should be lubricated with a special purpose switch lubricant. The product recommended for this purpose is Rykon lubricant No. 2 EP (American Oil Co.) mixed with Tuluol. It should be carefully applied in a very thin film with a camel's hair brush.



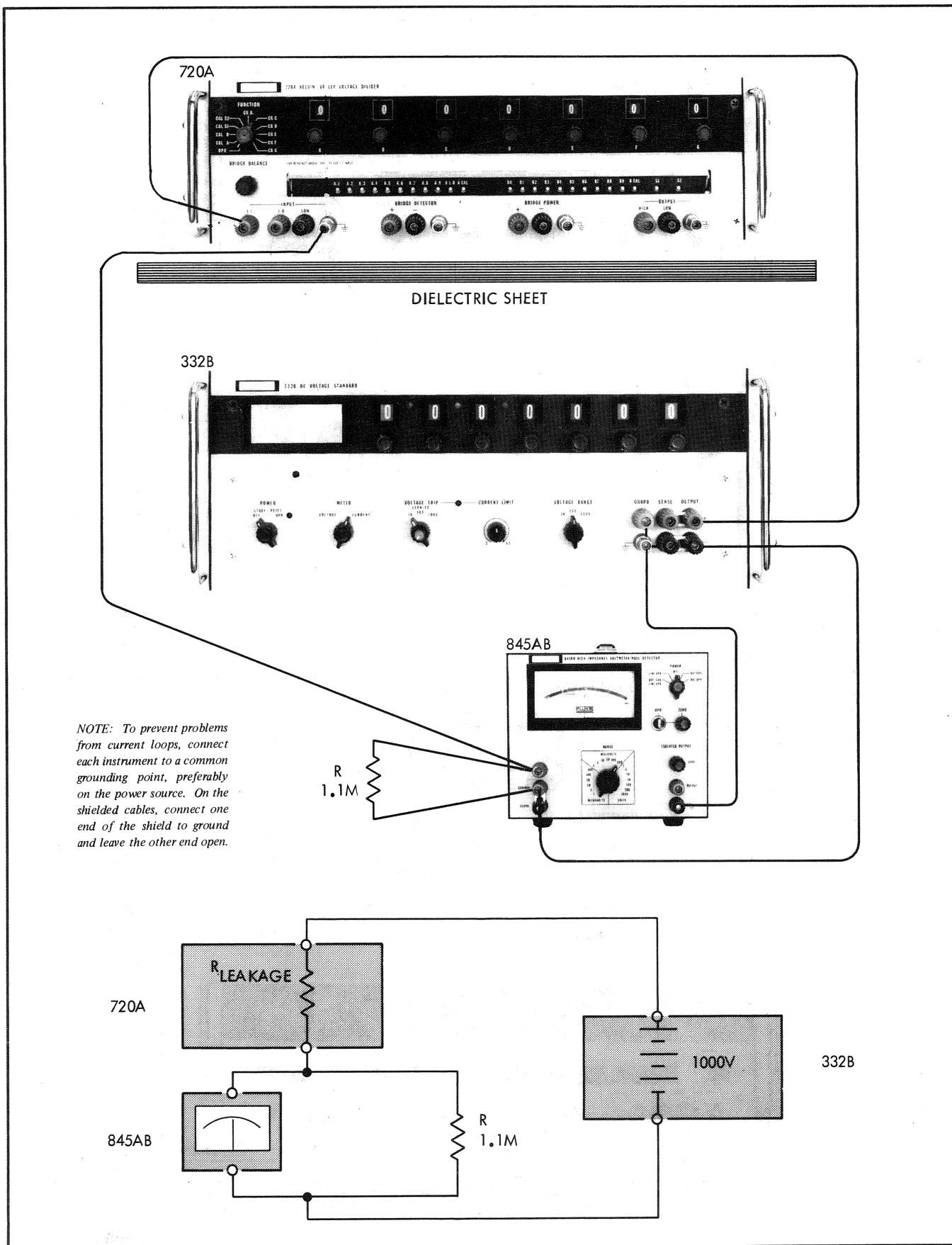

*NOTE: To prevent problems from current loops, connect each instrument to a common grounding point, preferably on the power source. On the shielded cables, connect one end of the shield to ground and leave the other end open.*

Figure 4-2. EQUIPMENT CONNECTIONS FOR LEAKAGE RESISTANCE TEST

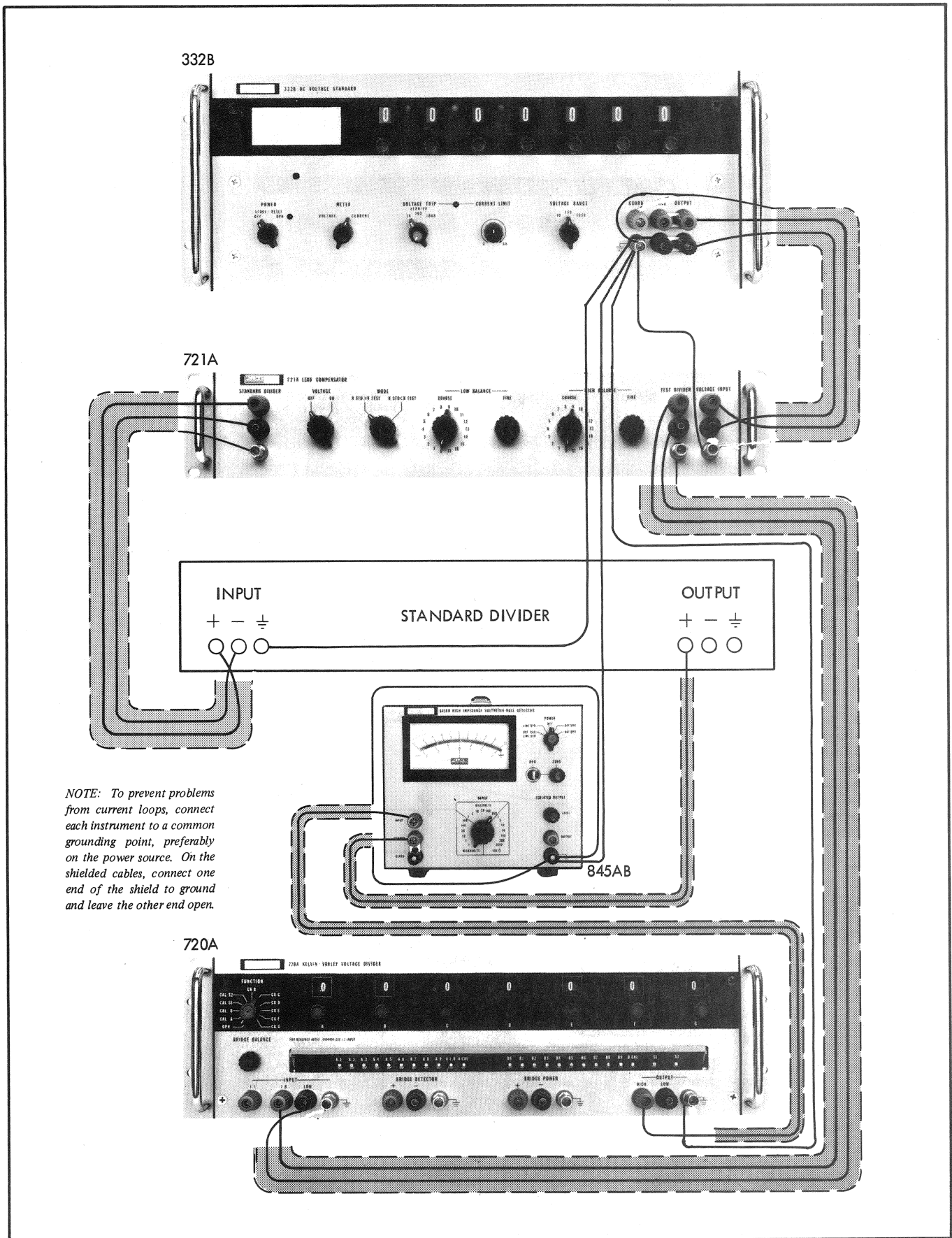

Figure 4-3. EQUIPMENT CONNECTIONS FOR LINEARITY COMPARISON TEST

**CAUTION!**

Great care should be used to avoid excessive use of contact lubricant on the switches of the Model 720A. The contacts should not be lubricated unless there is evidence of irregular operation.

Before applying the lubricant, clean the switch following the instructions in paragraph 4-10. Only a minute amount of lubricating fluid should be applied. After application, exercise the switch by rotating it through all positions several times.

**4-14. Linearity Testing**

4-15. The design of the 720A Voltage Divider is such that if the instrument is self-calibrated, if the leakage resistance is low, and if the switch contacts display repeatable contact resistance, the divider will meet its linearity specifications. Because of the extremely tight over-all specification (0.1 PPM of input) very few laboratories will have both the necessary equipment and the required technical skills to prove this. The following linearity test using a second Model 720A as a standard is therefore intended only to indicate gross errors (0.2 PPM of input) in the first decade and to prove specification on the lower decades. The customer who hopes to prove more than this is referred to the following articles and papers:

1. Andrew F. Dunn, "Calibration of a Kelvin-Varley Voltage Divider," National Research Council Report No. 7863.
2. M. L. Morgan and J. C. Riley, "Calibration of a Kelvin-Varley Standard Divider," IRE

Trans. on Instrumentation, vol. 1-9, pp 237-243; Sept. 1960.

4-16. To compare divider linearity, connect the equipment as shown in Figure 4-3 and proceed as follows:

*NOTE!*

Figure 4-4 is a schematic diagram of the test setup obtained by interconnecting the equipment as shown in Figure 4-3.

- a. Self-calibrate the Model 720A. (See paragraph 2-24 in Section II).
- b. Set both dividers to zero.
- c. Set the voltage source to the desired test voltage, turn on all equipment and allow it to warm up until it reaches temperature equilibrium.
- d. Place the null detector in the zero mode, adjust it for zero deflection, and return it to operating mode.
- e. Adjust the LOW BALANCE controls of the lead compensator to obtain a zero indication on the null detector.
- f. Turn the HIGH BALANCE COARSE control to the same setting as the LOW BALANCE COARSE control.

*NOTE!*

If the dividers are set from one calibration point to the next while the test setup is energized, the null detector meter will require several seconds to recover between readings. Measurement may

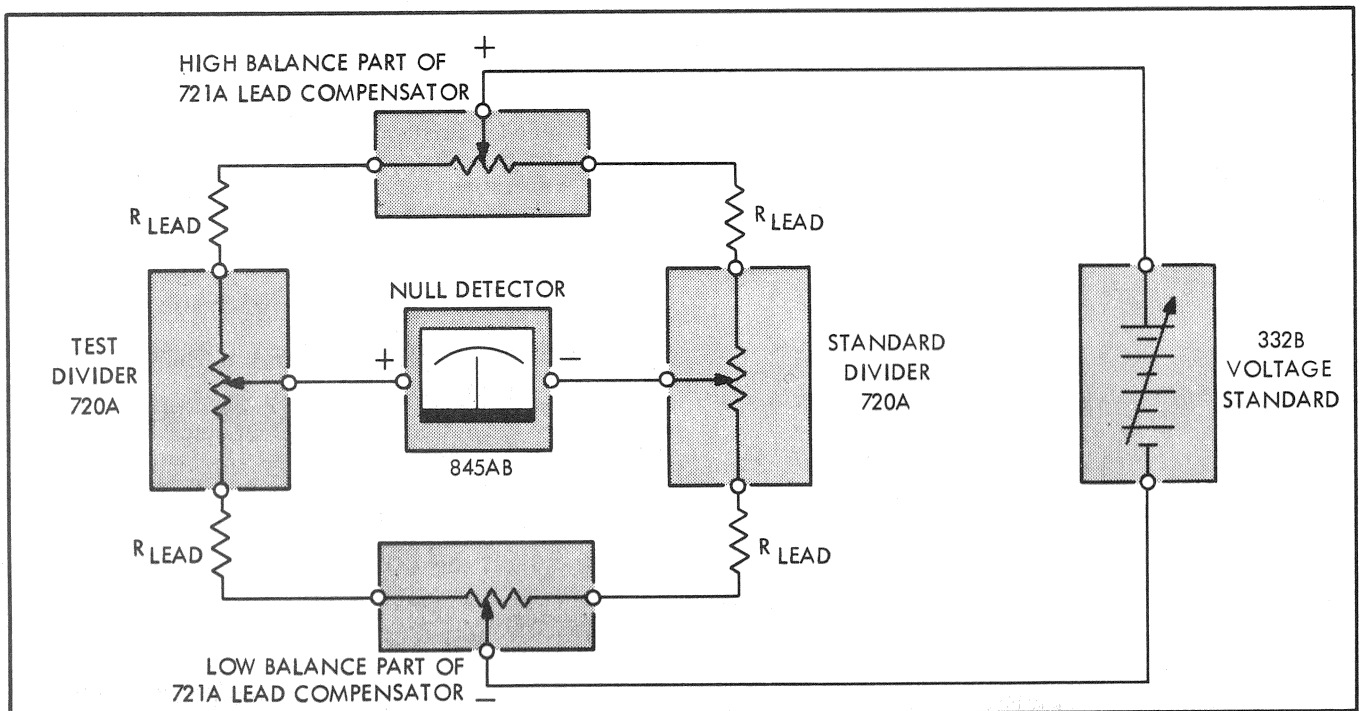

Figure 4-4. SIMPLIFIED SCHEMATIC DIAGRAM OF LINEARITY COMPARISON TEST

*be performed more rapidly if the VOLTAGE switch of the lead compensator is turned to OFF before switching. Measurement may be speeded further by turning the ZERO-OPR switch of the null detector to ZERO during switching. This prevents the transient caused by turning the voltage on from saturating the null detector amplifier.*

- g. Set both dividers to full scale and adjust the HIGH BALANCE FINE control to obtain a zero indication on the null detector.
- h. Set both dividers to zero and re-adjust the LOW BALANCE FINE control if necessary to obtain a zero indication on the null detector.
- i. Set the null detector to the desired sensitivity.
- j. Set both dividers to the first comparison point and adjust the standard divider for a near zero indication on the null detector. The dial settings of the two dividers plus the null detector reading shall agree within a tolerance of 0.2 PPM. This criterion is applicable for input voltages of 100 volts or less.
- k. Continue to compare each setting of each decade until the comparison is complete. The following dial setting combinations should be checked on each decade.

0 all zeros	_____
1 all zeros	1 (dial 09 and all 9 <sup>s</sup> except X in last)
2 all zeros	2 (dial 19 and all 9 <sup>s</sup> except X in last)
3 all zeros	3 (dial 29 and all 9 <sup>s</sup> except X in last)
4 all zeros	4 (dial 39 and all 9 <sup>s</sup> except X in last)
5 all zeros	5 (dial 49 and all 9 <sup>s</sup> except X in last)
6 all zeros	6 (dial 59 and all 9 <sup>s</sup> except X in last)
7 all zeros	7 (dial 69 and all 9 <sup>s</sup> except X in last)
8 all zeros	8 (dial 79 and all 9 <sup>s</sup> except X in last)
9 all zeros	9 (dial 89 and all 9 <sup>s</sup> except X in last)
1.0 all zeros	10 (dial 99 and all 9 <sup>s</sup> except X in last)
_____	1.1 (dial 1.09 and all 9 <sup>s</sup> except X in last)

#### 4-17. Decade Linearity Testing

4-18. The CK B through CK G positions of the FUNCTION switch are provided to permit access to the individual decades of the Model 720A under test so that each may be checked against the first decade of the standard divider. To test the linearity of each decade individually, proceed as follows:

- a. Change the test setup to that shown in Figure 4-5.

#### NOTE!

*Figure 4-6 is a schematic diagram of the test setup obtained by interconnecting the equipment as shown in Figure 4-5.*

- b. Turn the FUNCTION switch to CK B.
- c. Set the standard divider to zero.
- d. Set the divider under test to 1.0 000000.
- e. Set the voltage source to the desired test voltage.

#### CAUTION!

**Do not exceed the maximum test voltages listed in Figures 4-7 through 4-12.**

- f. Place the null detector in the zero mode, adjust it for zero deflection, and return it to operating mode.
- g. Adjust the LOW BALANCE controls of the lead compensator to obtain a zero indication on the null detector.
- h. Turn the HIGH BALANCE COARSE control to the same setting as the LOW BALANCE COARSE control.

#### NOTE!

*If the dividers are set from one calibration point to the next while the test setup is energized, the null detector meter will require several seconds to recover between readings. Measurement may be performed more rapidly if the VOLTAGE switch of the lead compensator is turned to OFF before switching. Measurement may be speeded further by turning the ZERO-OPR switch of the null detector to ZERO during switching. This prevents the transient caused by turning the voltage on, from saturating the null detector amplifier.*

- i. Set the standard divider to full scale.
- j. Set the divider under test to 1.0 99999X.
- k. Adjust the HIGH BALANCE FINE control to obtain a zero indication on the null detector.
- l. Set the divider under test back to 1.0 000000 and set the standard divider back to zero.
- m. Re-adjust the LOW BALANCE FINE control if necessary to obtain a zero indication on the null detector.
- n. Set the null detector for the desired sensitivity and make the linearity measurements given in Figure 4-7. The null detector indications must be

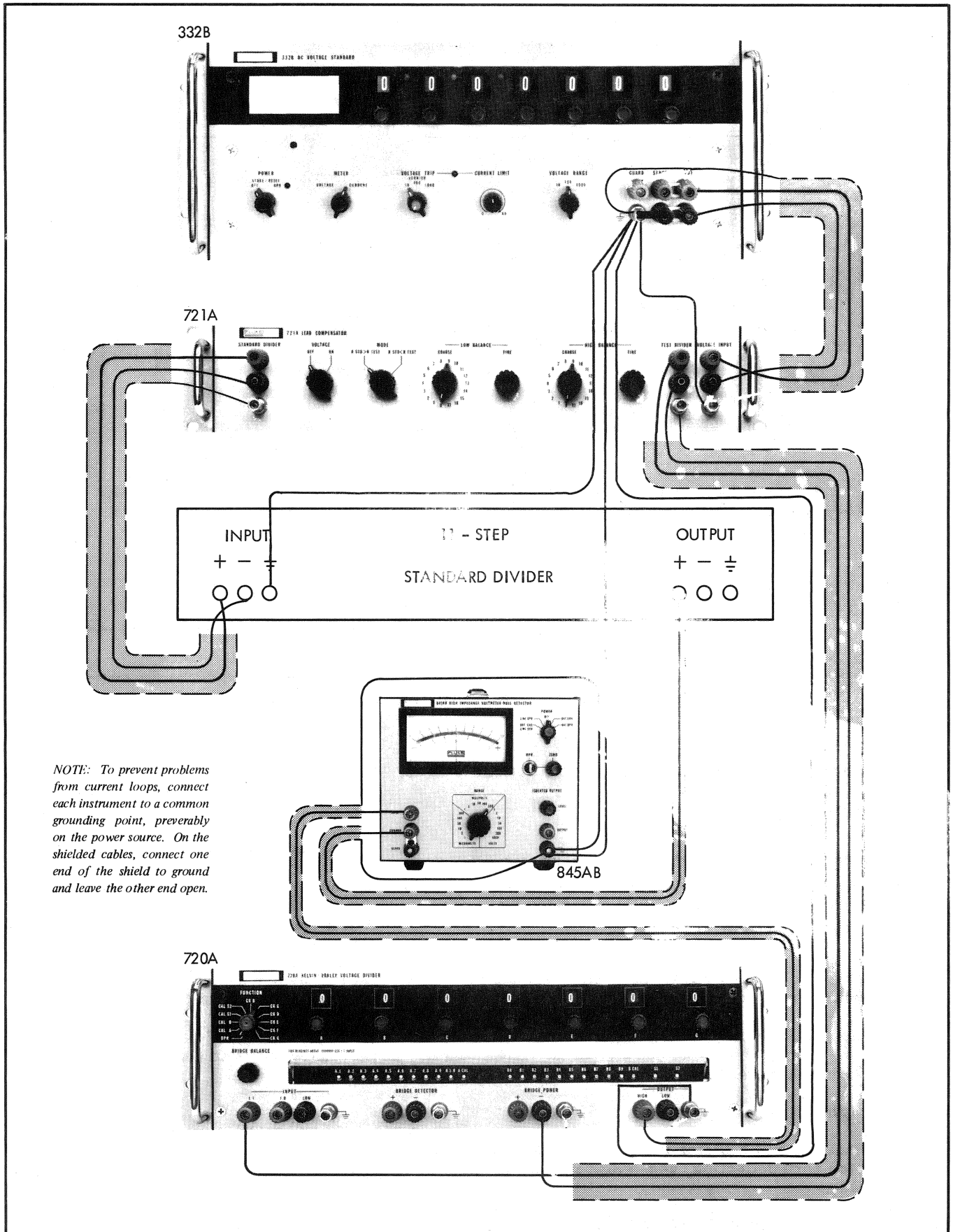

Figure 4-5. EQUIPMENT CONNECTIONS FOR DECADE LINEARITY TEST

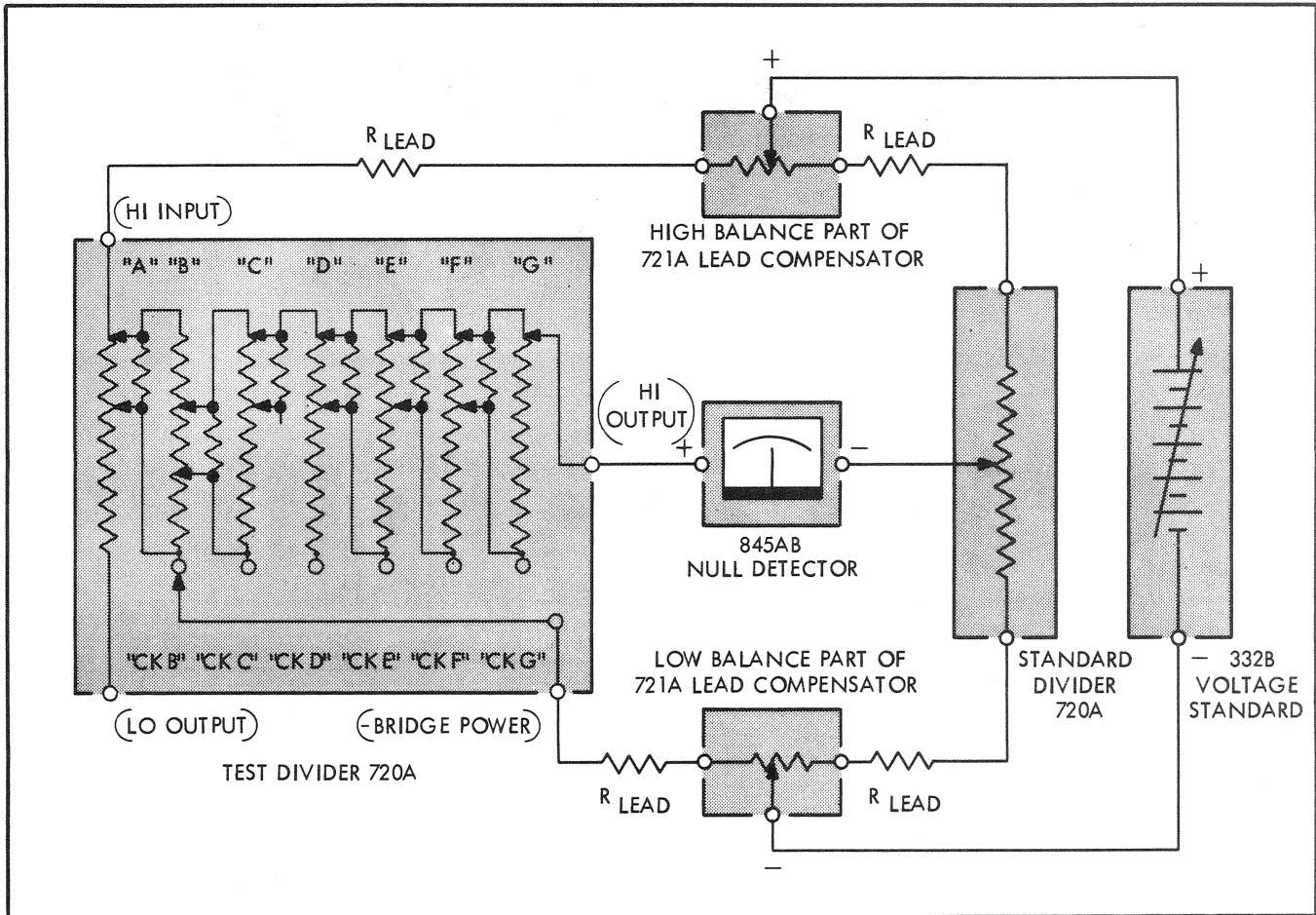

Figure 4-6. SIMPLIFIED SCHEMATIC DIAGRAM OF DECADE LINEARITY TEST

within the limits listed in the Permissible Deviation column.

**NOTE!**

*An indication beyond these limits is a symptom of trouble within the instrument. Refer to the troubleshooting instructions to determine the nature of the fault.*

- o. Set the voltage source to the desired voltage for testing the "C" decade.
- p. Turn the FUNCTION switch to CK C.
- q. Set the standard divider to zero.
- r. Set the divider under test to 1.0 900000.
- s. Place the null detector in the zero mode, adjust it for zero deflection, and return it to operating mode.
- t. Adjust the LOW BALANCE CONTROLS of the lead compensator to obtain a zero indication on the null detector.
- u. Turn the HIGH BALANCE COARSE control to the same setting as the LOW BALANCE COARSE control.
- v. Set the standard divider to full scale.
- w. Set the divider under test to 1.0 99999X.
- x. Adjust the HIGH BALANCE FINE control to obtain a zero indication on the null detector.
- y. Set the divider under test back to 1.0 900000 and set the standard divider back to zero.
- z. Re-adjust the LOW BALANCE FINE control if necessary to obtain a zero indication on the null detector.
- aa. Set the null detector for the desired sensitivity and make the linearity measurements listed in Figure 4-8.
- ab. Set the voltage source to the desired test voltage for testing "D" Decade.
- ac. Turn the FUNCTION switch to CK D.

SETTINGS		PERMISSIBLE DEVIATION PPM of INPUT to "B" DECADE	MAX. TEST VOLTAGE
STANDARD DIVIDER	720A		
0	<u>1.0</u> 000000	0	100V ↓
.1	<u>1.0</u> 100000	0.38	
.2	<u>1.0</u> 200000	0.45	
.3	<u>1.0</u> 300000	0.50	
.4	<u>1.0</u> 400000	0.54	
.5	<u>1.0</u> 500000	0.57	
.6	<u>1.0</u> 600000	0.60	
.7	<u>1.0</u> 700000	0.63	
.8	<u>1.0</u> 800000	0.65	
.9	<u>1.0</u> 900000	0.67	
.999999X	<u>1.0</u> 99999X	0	
.9	<u>1.0</u> 89999X	0.67	
.8	<u>1.0</u> 79999X	0.65	
.7	<u>1.0</u> 69999X	0.63	
.6	<u>1.0</u> 59999X	0.60	
.5	<u>1.0</u> 49999X	0.57	
.4	<u>1.0</u> 39999X	0.54	
.3	<u>1.0</u> 29999X	0.50	
.2	<u>1.0</u> 19999X	0.45	
.1	<u>1.0</u> 09999X	0.38	

Figure 4-7. "B" DECADE LINEARITY TEST

- ad. Set the standard divider to zero.
- ae. Set the divider under test to 1.0 990000.
- af. Place the null detector in the zero mode, adjust it for zero deflection, and return it to operating mode.
- ag. Adjust the LOW BALANCE controls of the lead compensator to obtain a zero indication on the null detector.
- ah. Turn the HIGH BALANCE COARSE control to the same setting as the LOW BALANCE COARSE control.
- ai. Set the standard divider to full scale.
- aj. Set the divider under test to 1.0 99999X.
- ak. Adjust the HIGH BALANCE FINE control to obtain a zero indication on the null detector.
- al. Set the divider under test back to 1.0 990000 and set the standard divider back to zero.
- am. Re-adjust the LOW BALANCE FINE control if necessary to obtain a zero indication on the null detector.
- an. Set the null detector for the desired sensitivity and make the linearity measurements given in Figure 4-9. The null detector indications must be within the limits listed in the "permissible deviation" column.

SETTINGS		PERMISSIBLE DEVIATION PPM of INPUT to "C" DECADE	MAX. TEST VOLTAGE
STANDARD DIVIDER	720A		
0	<u>1.0</u> 900000	0	100V ↓
.1	<u>1.0</u> 910000	1.4	
.2	<u>1.0</u> 920000	1.7	
.3	<u>1.0</u> 930000	1.9	
.4	<u>1.0</u> 940000	2.1	
.5	<u>1.0</u> 950000	2.3	
.6	<u>1.0</u> 960000	2.4	
.7	<u>1.0</u> 970000	2.5	
.8	<u>1.0</u> 980000	2.7	
.9	<u>1.0</u> 990000	2.8	
.999999X	<u>1.0</u> 99999X	0	
.9	<u>1.0</u> 98999X	2.8	
.8	<u>1.0</u> 97999X	2.7	
.7	<u>1.0</u> 96999X	2.5	
.6	<u>1.0</u> 95999X	2.4	
.5	<u>1.0</u> 94999X	2.3	
.4	<u>1.0</u> 93999X	2.1	
.3	<u>1.0</u> 92999X	1.9	
.2	<u>1.0</u> 91999X	1.7	
.1	<u>1.0</u> 90999X	1.4	

Figure 4-8. "C" DECADE LINEARITY TEST

- ao. Turn the FUNCTION switch to CK E.
- ap. Set the standard divider to zero.
- aq. Set the divider under test to 1.0 999000.
- ar. Place the null detector in the zero mode, adjust it for zero deflection, and return it to operating mode.
- as. Adjust the LOW BALANCE controls of the lead compensator to obtain a zero indication on the null detector.
- at. Turn the HIGH BALANCE COARSE control to the same setting as the LOW BALANCE COARSE control.
- au. Set the standard divider to full scale.
- av. Set the divider under test to 1.0 99999X.
- aw. Adjust the HIGH BALANCE FINE control to obtain a zero indication on the null detector.
- ax. Set the divider under test back to 1.0 999000 and set the standard divider back to zero.



SETTINGS		PERMISSIBLE DEVIATION PPM of INPUT to "D" DECADE	MAX. TEST VOLTAGE
STANDARD DIVIDER	720A		
0	<u>1.0</u> 990000	0	10V ↓
.1	<u>1.0</u> 991000	6.0	
.2	<u>1.0</u> 992000	7.5	
.3	<u>1.0</u> 993000	8.6	
.4	<u>1.0</u> 994000	9.5	
.5	<u>1.0</u> 995000	10.2	
.6	<u>1.0</u> 996000	10.8	
.7	<u>1.0</u> 997000	11.4	
.8	<u>1.0</u> 998000	12.0	
.9	<u>1.0</u> 999000	12.5	
.999999X	<u>1.0</u> 99999X	0	
.9	<u>1.0</u> 99899X	12.5	
.8	<u>1.0</u> 99799X	12.0	
.7	<u>1.0</u> 99699X	11.4	
.6	<u>1.0</u> 99599X	10.8	
.5	<u>1.0</u> 99499X	10.2	
.4	<u>1.0</u> 99399X	9.5	
.3	<u>1.0</u> 99299X	8.6	
.2	<u>1.0</u> 99199X	7.5	
.1	<u>1.0</u> 99099X	6.0	

Figure 4-9. "D" DECADE LINEARITY TEST

- ay. Re-adjust the LOW BALANCE FINE control if necessary to obtain a zero indication on the null detector.
- az. Set the null detector for the desired sensitivity and make the linearity measurement given in Figure 4-10. The null detector indications must be within the limits listed in the "permissible deviation" column.
- ba. Turn the FUNCTION switch to CK F.
- bb. Set the standard divider to zero.
- bc. Set the divider under test 1.0 999900.
- bd. Place the null detector in the zero mode, adjust it for zero deflection, and return it to operating mode.
- be. Adjust the LOW BALANCE controls of the lead compensator to obtain a zero indication on the null detector.
- bf. Turn the HIGH BALANCE COARSE control to the same setting as the LOW BALANCE COARSE control.
- bg. Set the standard divider to full scale.
- bh. Set the divider under test to 1.0 99999X.
- bi. Adjust the HIGH BALANCE FINE control to obtain a zero indication on the null detector.

SETTINGS		PERMISSIBLE DEVIATION PPM of INPUT to "E" DECADE	MAX. TEST VOLTAGE
STANDARD DIVIDER	720A		
0	<u>1.0</u> 999000	0	10V ↓
.1	<u>1.0</u> 999100	28	
.2	<u>1.0</u> 999200	35	
.3	<u>1.0</u> 999300	40	
.4	<u>1.0</u> 999400	44	
.5	<u>1.0</u> 999500	47	
.6	<u>1.0</u> 999600	50	
.7	<u>1.0</u> 999700	53	
.8	<u>1.0</u> 999800	55	
.9	<u>1.0</u> 999900	57	
.999999X	<u>1.0</u> 999990	0	
.9	<u>1.0</u> 99989X	57	
.8	<u>1.0</u> 99979X	55	
.7	<u>1.0</u> 99969X	53	
.6	<u>1.0</u> 99959X	50	
.5	<u>1.0</u> 99949X	47	
.4	<u>1.0</u> 99939X	44	
.3	<u>1.0</u> 99929X	40	
.2	<u>1.0</u> 99919X	35	
.1	<u>1.0</u> 99909X	28	

Figure 4-10. "E" DECADE LINEARITY TEST

- bj. Set the divider under test back to 1.0 999900 and set the standard divider back to zero.
- bk. Re-adjust the LOW BALANCE FINE control if necessary to obtain zero indication on the null detector.
- bl. Set the null detector for the desired sensitivity and make the linearity measurements given in Figure 4-11. The null detector indications must be within the limits listed in the "permissible deviation" column.
- bm. Turn the FUNCTION switch to CK G.
- bn. Set the standard divider to zero.
- bo. Set the divider under test to 1.0 999990.
- bp. Place the null detector in the zero mode, adjust it for zero deflection, and return it to operating mode.
- bq. Adjust the LOW BALANCE controls of the lead compensator to obtain a zero indication on the null detector.
- br. Turn the HIGH BALANCE COARSE control to the same setting as the LOW BALANCE COARSE control.
- bs. Set the standard divider to full scale.
- bt. Set the divider under test to 1.0 99999X.

SETTINGS		PERMISSIBLE DEVIATION PPM of INPUT to "F" DECADE	MAX. TEST VOLTAGE
STANDARD DIVIDER	720A		
0	<u>1.0</u> 999900	0	10V ↓
.1	<u>1.0</u> 999910	130	
.2	<u>1.0</u> 999920	160	
.3	<u>1.0</u> 999930	180	
.4	<u>1.0</u> 999940	200	
.5	<u>1.0</u> 999950	220	
.6	<u>1.0</u> 999960	230	
.7	<u>1.0</u> 999970	240	
.8	<u>1.0</u> 999980	260	
.9	<u>1.0</u> 999990	270	
.999999X	<u>1.0</u> 99999X	0	
.9	<u>1.0</u> 99998X	270	
.8	<u>1.0</u> 99997X	260	
.7	<u>1.0</u> 99996X	240	
.6	<u>1.0</u> 99995X	230	
.5	<u>1.0</u> 99994X	220	
.4	<u>1.0</u> 99993X	200	
.3	<u>1.0</u> 99992X	180	
.2	<u>1.0</u> 99991X	160	
.1	<u>1.0</u> 99990X	130	

Figure 4-11. "F" DECADE LINEARITY TEST

- bu. Adjust the HIGH BALANCE FINE control to obtain a zero indication on the null detector.
- bv. Set the divider under test back to 1.0 999990 and set the standard divider back to zero.
- bw. Re-adjust the LOW BALANCE FINE control if necessary to obtain a zero indication on the null detector.
- bx. Set the null detector for the desired sensitivity and make the linearity measurements given in Figure 4-12. The null detector indications must be within the limits listed in the "permissible deviation" column.
- by. Disconnect the test equipment and return the FUNC-

TION switch to OPR position; the decade linearity tests are complete.

#### 4-19. CALIBRATION

4-20. Calibration of the Model 720A consists of calibrating two standard resistance arms of the internal Wheatstone bridge and calibrating the first three decades. The bridge arms require calibration only if the BRIDGE BALANCE control has insufficient range to balance the bridge during divider calibration.

#### 4-21. Divider Calibration

4-22. This procedure is used to adjust the linearity of the "A", "B" and "C" decades of the Model 720A so

SETTINGS		PERMISSIBLE DEVIATION PPM of INPUT to "G" DECADE	MAX. TEST VOLTAGE
STANDARD DIVIDER	720A		
0	<u>1.0</u> 999990	0	10V
.1	<u>1.0</u> 999991	600	↓
.2	<u>1.0</u> 999992	750	
.3	<u>1.0</u> 999993	860	
.4	<u>1.0</u> 999994	950	
.5	<u>1.0</u> 999995	1020	
.6	<u>1.0</u> 999996	1080	
.7	<u>1.0</u> 999997	1140	
.8	<u>1.0</u> 999998	1200	
.9	<u>1.0</u> 999999	1250	
.999999X	<u>1.0</u> 99999X	0	

Figure 4-12. "G" DECADE LINEARITY TEST

that any readout setting is accurate within 0.1 ppm of input. This procedure consists of two parts, calibration of the "C" decade and the "S3" shunt, and calibration of the "A" and "B" decades, and their shunts. The latter is the self calibration procedure which is performed from the front panel.

4-23. To calibrate the "C" decade and "S3" shunt proceed as follows:

*NOTE!*

*Insure the system has the correct connections and ground as shown in Figure 4-14.*

- a. Turn the FUNCTION switch to OPR, turn the internal FUNCTION switch to CAL C, exercise the "C" decade switch by turning it twice through all positions, and set the readout to .000000.
- b. Connect the voltage source to the red and the black BRIDGE POWER binding posts.
- c. Connect the null detector to the BRIDGE DETECTOR binding posts. The guard terminal of the null detector must be connected to the common terminal.

- d. Turn the B decade switch to the blank position and apply 10 volts from the voltage source.
- e. Adjust the BRIDGE BALANCE control to obtain a null indication  $\pm 10$  microvolts.

*NOTE!*

*If the null meter cannot be nulled using the Bridge Balance Control, perform the Bridge Calibration Procedure (paragraph 4-25).*

- f. Locate the C-0 trimmer (R1130) on the circuit board and sweep it slowly from stop to stop while observing the null detector. If the indication does not change smoothly, sweep it from stop to stop several times.
- g. Set the null detector to the 30 microvolt range and adjust the C-0 trimmer to obtain an indication of  $0 \pm 10$  microvolts.
- h. Observe the null detector and tap the trimmer; the indication should remain within 10 microvolts of zero.

- i. Use the following procedure to calibrate the "C" deck switch positions 1 through CAL:
    - 1. Turn the "C" deck switch clockwise to the next position to be calibrated.
    - 2. Observe the null detector and slowly sweep the trimmer corresponding to the switch position (C-1 through C CAL) from stop to stop. If the indication does not change smoothly, sweep the trimmer from stop to stop several times.
    - 3. Observe the null detector and adjust the trimmer to obtain an indication of  $0 \pm 10$  microvolts.
    - 4. Observe the null detector and tap the trimmer; the indication should stay within 10 microvolts of the zero.
    - 5. Turn the "C" deck switch away from the position being calibrated, return it and observe the meter. The indication should be within 10 microvolts of zero
  - o. Turn the "C" decade switch away from the 0 positions and return it to zero. The null detector indication should be within 10 microvolts of zero.
  - p. Return the internal FUNCTION switch to OPR; Calibration of the "C" decade and S3 shunt is complete.
- 4-24. To calibrate the "A" and "B" decades, perform the self-calibration procedure using the instructions given in paragraphs 2-24 and 2-25.

#### 4-25. Bridge Calibration

*NOTE!*

*The Bridge Calibration procedure is required only if a null could not be obtained during Divider Calibration with the BRIDGE BALANCE Control.*

*If the indication is not within 10 microvolts of zero, exercise the switch and repeat the procedure. If this fails, lubricate the switch as instructed in paragraph 4-12.*

- 6. Proceed to the next position to be calibrated.
- j. Return the "C" deck switch to the 0 position.
- k. Turn the internal FUNCTION switch to the CAL S3 position.
- l. Observe the null detector and slowly sweep the CAL S3 trimmer from stop to stop. If the indication does not change smoothly, sweep it from stop to stop several times.
- m. Adjust the CAL S3 trimmer to obtain an indication of  $0 \pm 10$  microvolts.
- n. Observe the null detector and tap the trimmer. The indication should stay within 10 microvolts of zero.
- a. Turn the FUNCTION switch to CAL A; turn the internal FUNCTION switch to OPR (Fig. 4-13) and set the readout to .0000000.
- b. Connect a 20 volt DC source to the red and the black BRIDGE POWER binding posts.
- c. Connect the null detector to the BRIDGE DETECTOR binding posts. The guard terminal of the null detector must be connected to the Common terminal.

*NOTE!*

*Insure the system has the correct connections and ground as shown in Figure 4-14.*

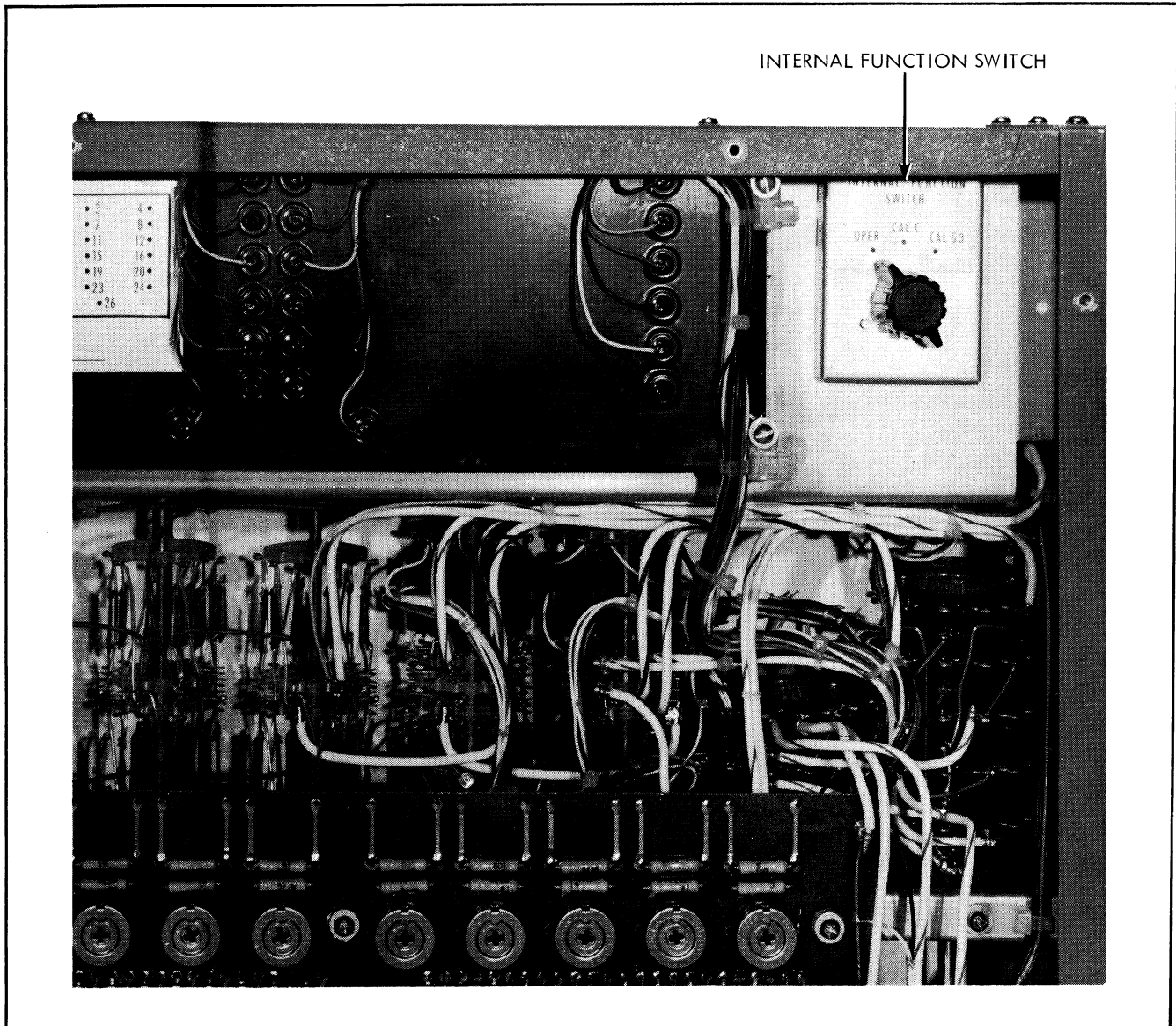

Figure 4-13. INTERNAL FUNCTION SWITCH

- d. Adjust the Bridge Balance control to the center of its travel range.

**NOTE!**

*BRIDGE BALANCE is a concentric control with both a Fine and Coarse range on the same control knob.*

- e. Observe the null detector and sweep R203 on the bridge circuit board slowly from stop to stop. If the indication does not change smoothly, sweep R203 from stop to stop several times.
- f. Adjust R203 to obtain an indication of  $0 \pm 100$  microvolts.
- g. Select the one millivolt range on the null detector. Vary the Bridge Balance control while observing the null detector. When the electrical center is obtained, leave the BRIDGE BALANCE control at that position.
- h. Re-adjust R203 to obtain an indication of  $0 \pm 100$  microvolts
- i. Calibration of the 10-kilohm bridge standard is complete.

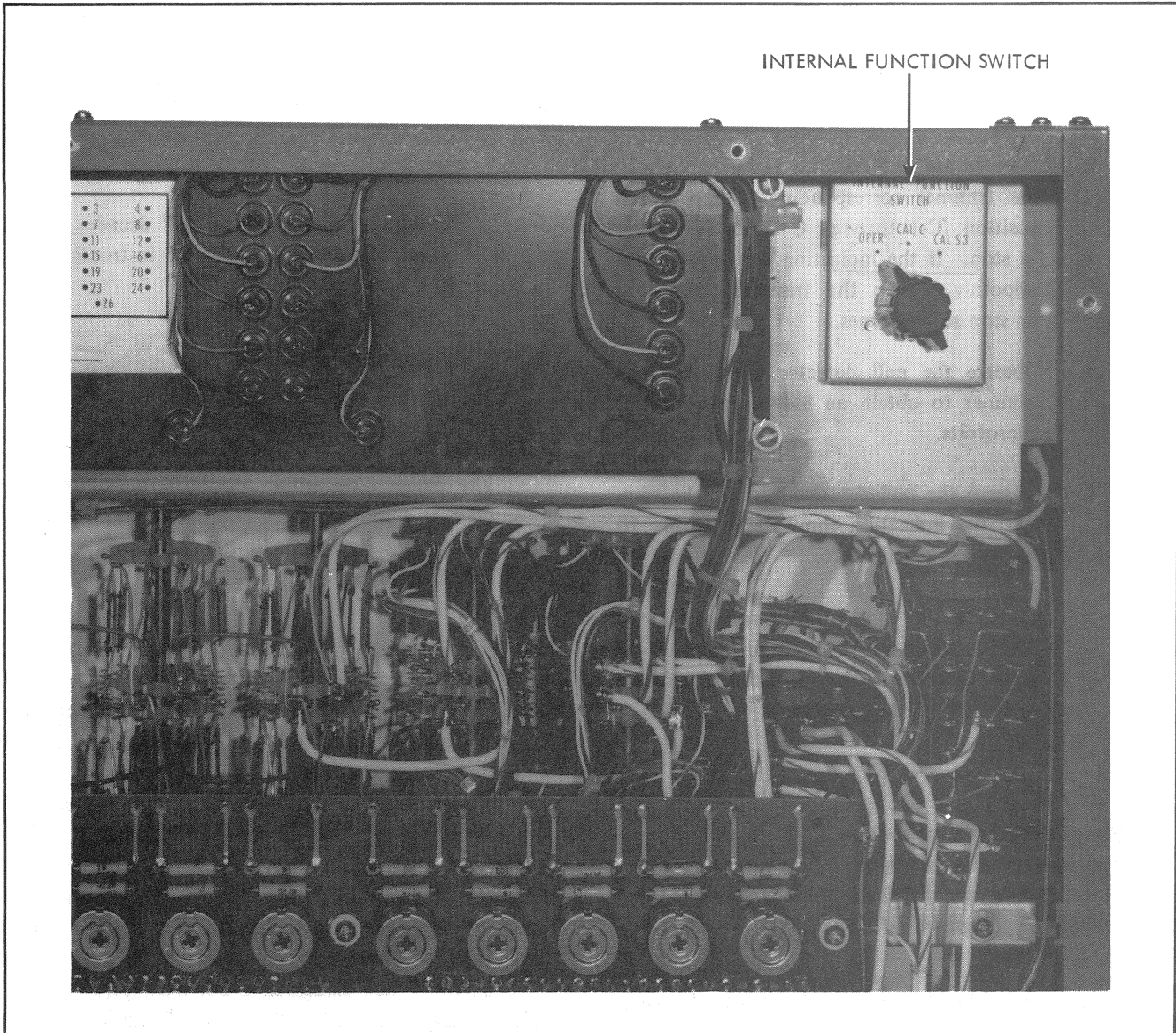

Figure 4-13. INTERNAL FUNCTION SWITCH

- d. Adjust the Bridge Balance control to the center of its travel range.

**NOTE!**

*BRIDGE BALANCE is a concentric control with both a Fine and Coarse range on the same control knob.*

- e. Observe the null detector and sweep R203 on the bridge circuit board slowly from stop to stop. If the indication does not change smoothly, sweep R203 from stop to stop several times.
- f. Adjust R203 to obtain an indication of  $0 \pm 100$

microvolts.

- g. Select the one millivolt range on the null detector. Vary the Bridge Balance control while observing the null detector. When the electrical center is obtained, leave the BRIDGE BALANCE control at that position.
- h. Re-adjust R203 to obtain an indication of  $0 \pm 100$  microvolts
- i. Calibration of the 10-kilohm bridge standard is complete.

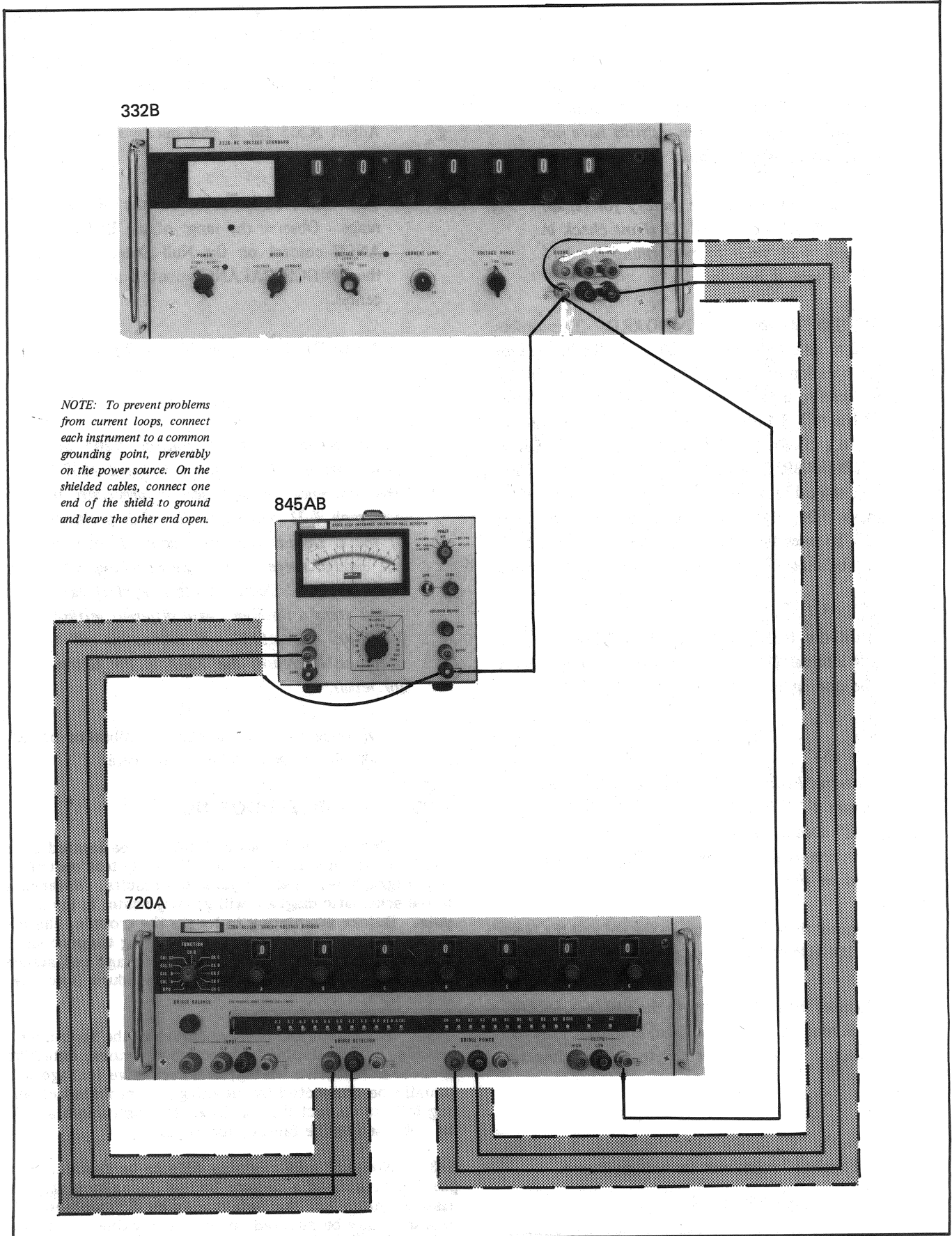

Figure 4-14. EQUIPMENT CONNECTIONS FOR SELF CALIBRATION.



**NOTE!**

*The BRIDGE BALANCE control and R203 are now ready for the self-cal procedures for A and B decades in paragraph 2-24, assuming R312 and its associated trim resistors have not shifted excessively in value. If insufficient trim range remains at A.1, A.2, etc., the 720A should be returned to the factory for repair. Perform the C decade and S3 shunt check in paragraph 4-21 prior to performing the self-cal at A and B decades.*

4-27. **4-KILOHM BRIDGE STANDARD.** This procedure is used to adjust the total resistance of the bridge arm used for calibration of the third "C" decade so the bridge can be balanced to measure a nominal 4007.6 ohms. Calibration of the "C" decade consists of setting each step on the decade to a nominal 4007.6 ohms. If the bridge can be balanced with the BRIDGE BALANCE control on the front panel during self-cal in the CAL C - Zero position described in paragraph 4-21, this procedure does not need to be performed. To reset the range of the BRIDGE BALANCE control for balance of the bridge, perform the following procedure:

- a. Turn the FUNCTION switch to OPR, and turn the internal FUNCTION switch to CAL C, and set the readout to .0000000.

**NOTE!**

*The internal FUNCTION switch, which is shown in Figure 4-13, is used only for calibration of the "C" decade and the S-3 shunt. It should not be confused with the FUNCTION switch located on the front panel.*

- b. Connect the voltage source to the red and the black BRIDGE POWER binding posts.
- c. Connect the null detector to the BRIDGE DETECTOR binding posts. The guard terminal of the null detector must be connected to the common terminal.
- d. Turn the "C" decade switch to the blank position and apply 10 volts from the voltage source.
- e. Adjust BRIDGE BALANCE to the mid-position and adjust R1130 (Decade C-9) to mid position

- f. Observing the Null Detector sweep R205 (Bridge Circuit Board) thru its range. If the null detector does not show a smooth change, sweep R205 through its range several times.
- g. Adjust R205 for  $0 \pm 50$  microvolts on the Null Detector.
- h. Place the Null Detector on the 300 microvolt range. Observe the range of the BRIDGE BALANCE control on the Null Detector and place the BRIDGE BALANCE control at the electrical center.
- i. Adjust R1130 (Decade C-0) for  $0 \pm 10$  microvolts.

**NOTE!**

*The BRIDGE BALANCE control, R205 and R1130 are now set to give a nominal 4007.6 ohm reference and the self-cal procedure in paragraph 4-21 will make the other positions of the C Decade the same value. If there is not enough range to trim the remaining positions of the C Decade to this nominal value repeat steps a through i with different settings for R205 and R1130. If calibration still is not possible, return the 720A to the factory for repair.*

- j. Disconnect the test equipment; calibration of the 4-kilohm bridge standard is complete.

**4-28. TROUBLESHOOTING**

4-29. Troubles in the Model 720A may be located most easily by performing the decade linearity test described in paragraph 4-15 and analyzing the results. Reference to the schematic diagram will greatly assist in the analysis. Before attempting to locate the trouble, the instrument should first be cleaned following the procedure described in paragraph 4-10 and the leakage resistance should be measured following the procedure described in paragraph 4-8.

4-30. Because of the passive nature of the instrument, troubles will be limited to defective resistors, defective switches, defective wiring, and excessive leakage will usually be corrected by cleaning. If repeated cleaning fails to correct the condition, the instrument should be returned to the factory for repair.

4-31. Not only may resistor defects be isolated to a particular step of a decade by the linearity test, but also the nature of the defect may be determined. A resistor may be shorted, open, over value, or under value. Because the switch contacts span two steps of resistance in all decades except the seventh ("G"), the

effect caused directly by a defective resistor will be seen at two adjacent switch positions. In the "D" through "G" decades the linearity test will isolate the defect to a particular resistor. In the "A", "B", and "C", decades each step is made up of several resistors and each resistor in the step will have to be measured to find the defect. In these decades, the variable trimmer resistor in the defective step should be checked by monitoring it and sweeping it from stop to stop several times. If the variation is not smooth, it should be replaced. If one of the resistors in the oil tank or one of the factory selected fixed resistors is found to be defective, the instrument should be returned to the factory for repair.

4-32. A shorted resistor will decrease the overall resistance of the decade thereby increasing the proportional value of all steps except the one containing the shorted resistor. The proportional value of this step will be very low.

4-33. An open resistor in any decade will prevent any output until the switch is advanced so the contacts span the open resistor. At this point the ratio will be high. As the switch is advanced so the contacts no longer span the open resistor, the measured output will be the source voltage. If a decade shunt is open all steps of the decade will be equal but resistance of the decade will be high. This will cause nonlinearity in the preceding decade which may be observed by dialing it upward from zero. Below the midpoint, the output will be high; above the midpoint, the output will be low.

4-34. An over value resistor in any decade will reduce the proportion of all other steps and increase the proportion of the step containing the over value resistor. In all decades except the seventh, this increase will be seen at two adjacent switch positions because the switch contacts span two resistance steps. In the seventh decade, there will be only one over value step. If a decade shunt is over value, all steps of the decade will be equal but the resistance of the decade will be high. This will cause nonlinearity in the preceding decade which may be observed by dialing it upward from zero. Below the midpoint, the output will be high; above the midpoint, the output will be low.

4-35. An under value resistor in any decade will increase the proportion of all other steps and decrease the proportion of the step containing the under value resistor. In all decades except the seventh, this decrease will be seen at two adjacent switch positions. In the seventh decade there will be only one under value step. If a decade shunt is under value, all steps of the decade will be equal but the resistance of the decade will be low. This will cause nonlinearity in the preceding decade which may be observed by dialing it upward from zero. Below the midpoint, the output will be low; above the midpoint, the output will be high.

4-36. A defective switch usually will cause erratic or irregular operation of the decade. A broken contact may cause one step to be missing although all others are of the correct value or it may completely open the divider circuit. When a switch defect is suspected, the switch should be checked for continuity at each position.

4-37. Defective wiring usually will cause one step of a decade to be missing or will completely open the divider circuit. Wiring continuity should be checked to isolate the fault.

#### 4-38. REPAIR

4-39. Any parts of the Model 720A except factory selected resistors and resistors housed in the oil tank may be replaced without difficulty by an experienced electronic maintenance technician. When a switch is replaced all leads should be tagged as they are disconnected to assure that they are correctly connected to the new switch. Care should be exercised in any soldering operation to assure that good electrical contact is made. All parts except precision wirewound resistors may be ordered from the factory by giving only the information specified in paragraph 5-4.

4-40. The precision wirewound resistors used in the Model 720A are selected and matched during manufacture to form a completely matched set. Sufficient information is marked on each of these resistors to permit replacement with a resistor which will match the others in the set. The following information should be given when one of these resistors is ordered from the factory:

- a. Serial number of the instrument.
- b. Reference designation of the resistor.
- c. All markings on the resistor.

If all markings on the defective resistor can not be read, give the following information:

- a. Serial number of the instrument.
- b. Reference designation of the defective resistor.
- c. Reference designation and all part markings of the adjacent resistor on one side.
- d. Reference designation and all part markings of the adjacent resistor on the other side.

#### 4-41. SERVICE INFORMATION

4-42. The John Fluke Manufacturing Co., Inc. warrants each instrument manufactured by them for the period of one year upon making delivery of the instrument to you, the original purchaser. Complete warranty page located at the rear of this manual.

4-43. If you should encounter any problem in the operation of your instrument, please feel free to contact your nearest John Fluke Sales Representative or write directly to the John Fluke Manufacturing Co., Inc. with a statement of your problem.

---

## Section 5

# List of Replaceable Parts

---

### 5-1. INTRODUCTION

5-2. This section contains complete descriptions of those parts one might normally expect to replace during the life of the instrument. The first listing is a breakdown of all of the major assemblies in the instrument. Subsequent listings itemize the components in each assembly. Every listing is accompanied by an illustration identifying each component in the listing. Assemblies and subassemblies are identified by name in the parts list and by a ten digit stock number in the illustrations. Components are identified by the schematic diagram reference designation (e.g. R1, C107 DS1). Parts not appearing on the schematic diagram are numbered consecutively throughout the parts list with a whole number. Flagnotes are used throughout the parts list and refer to ordering explanations. The flagnote explanations appear at the end of the parts list in which they are listed.

### 5-3. COLUMNAR INFORMATION

- a. The REF DESIG column indexes the item description to the associated illustration. In general the reference designations are listed under each assembly in alpha-numeric order. Subassemblies of minor proportions are sometimes listed with the assembly of which they are a part. In this case, the reference designations for the components of the subassembly may appear out of order.
- b. The DESCRIPTION column describes the salient characteristics of the component. Indention of the description indicates the relationship to other assemblies, components, etc. In many cases it is necessary to abbreviate in this column. For abbreviations and symbols used, see the following page.
- c. The ten-digit part number by which the item is identified at the John Fluke Mfg. Co. is listed in the STOCK NO. column. Use this number when ordering parts from the factory or authorized representatives.
- d. The Federal Supply Code for the item manufacturer is listed in the MFR column. An abbreviated list of Federal Supply Codes is included in the Appendix.
- e. The part number which uniquely identifies the item to the original manufacturer is listed in the MFR PART NO column. If a component must be ordered by description, the type number is listed.
- f. The TOT QTY column lists the total quantity of the item used in the instrument. Second and subsequent listing of the same item are referenced to the first listing with the abbreviation REF. In the case of optional subassemblies, plug ins, etc. that are not always part of the instrument, the TOT QTY column lists the total quantity of the item in that particular assembly.
- g. Entries in the REC QTY column indicate the recommended number of spare parts necessary to support one to five instruments for a period of two years. This list presumes an availability of common electronic parts at the maintenance site. For maintenance for one year or more at an isolated site, it is recommended that at least one of every part in the instrument be stocked.
- h. The USE CODE column identifies certain parts which have been added, deleted or modified during the production of the instrument. Each part for which a Use Code has been assigned may be identified with a particular instrument serial number by consulting the Serial Number Effectivity List. As Use Codes are added to the list, the TOT QTY column listings are changed to reflect the most current information. Sometimes when a part is changed, the new part can and should be used as a replacement for the original part. In this event a parenthetical note is added in the DESCRIPTION column.

## 5-4. HOW TO OBTAIN PARTS

5-5. Standard components have been used wherever possible. Standard components may be ordered directly from the manufacturer by using the manufacturer's part number, or parts may be ordered from the John Fluke Mfg. Co. factory or authorized representative by using the Fluke part number. In the event the part you order has been replaced by a new or improved part, the replacement will be accompanied by an explanatory note and installation instructions, if necessary.

5-6. You can insure prompt and efficient handling of your order to the John Fluke Mfg. Co. if you include the following information:

- a. Quantity.
- b. FLUKE Stock Number.
- c. Description.
- d. Reference Designation.
- e. Instrument model and serial number.

Example; 2 each, 4805-177105, Transistors, 2N3565, Q107-108 for 845AR, s/n 168.

If you must order structural parts not listed in the parts list, describe the part as completely as possible. A sketch of the part showing its location to other parts of the instrument is usually most helpful.

## 5-8. SERIAL NUMBER EFFECTIVITY

5-9. A Use Code column is provided to identify certain parts that have been added, deleted, or modified during production of the Model 720A. Each part for which a use code has been assigned may be identified with a particular instrument serial number by consulting the Use Code Effectivity List below. All parts with no code are used on all instruments with serial numbers above 123. New codes will be added as required by instrument changes.

USE CODE	EFFECTIVITY
No Code	Model 720A, serial number 123 and on.
A	Model 720A, serial number 536 and on.

REF DESIG	DESCRIPTION	STOCK NO	MFR	MFR PART NO	TOT QTY	REC QTY	USE CODE
	<b>KELVIN-VARLEY VOLTAGE DIVIDER</b> <b>Figure 5-1</b>	720A					
	Front Panel Assembly (See Figure 5-2)						
	Trimmer P/C Assembly (See Figure 5-3)	1702-210716 (720A-4001)	89536	1702-210716	1		
	Bridge P/C Assembly (See Figure 5-4)	1702-200295 (720A-4002)	89536	1702-200295	1		
	Resistor Can Assembly If a resistor in this assembly requires replacement, the entire instrument must be returned to the factory for repair and recalibration.	3158-217612 (720A-4018)	89536	3158-217612	1		
S1	Switch, "A" DECADE, rotary, 3p, 12 pos, 3 sect	5105-220012	89536	5105-220012	1		
	"B" Decade Switch Assembly (See Figure 5-5)	5110-217307 (720A-4004)	89536	5110-217307	1		
	"C" Decade Switch Assembly (See Figure 5-6)	5110-217315 (720A-4005)	89536	5110-217315	1		
	"D", "E", "F" and "G" Decades Switch Assy. (See Figure 5-7)	5110-217323 (720A-4006)	89536	5110-217323	1		
S8	Switch, FUNCTION, 5p, 11 pos, 5 sect	5105-220020	89536	5105-220020	1		
S9	Switch, INTERNAL FUNCTION, 4p, 3 pos, 2 sect	5107-218560	89536	5107-218560	1		
1	Bushing, dial	2502-130435	89536	2502-130435	7		
1	Bushing, dial	3153-130252	89536	3153-130252	7		A
2	Coupler, switch (not illustrated)	2402-200592	89536	2402-200592	7		
3	Cover, bottom (not illustrated)	3156-217117	89536	3156-217117	1		
4	Cover, internal function switch	3156-217521	89536	3156-217521	1		
5	Cover, top (not illustrated)	3156-217125	89536	3156-217125	1		
6	Detent, switch	5108-218578	89536	5108-218578	6		
7	Detent, internal function switch (not illustrated)	5108-218552	89536	5108-218552	1		
8	Dial, 0.0 - 1.0 Cal	2403-208611	89536	2403-208611	1		
9	Dial, 0 - Cal	2403-208595	89536	2403-208595	2		
10	Dial, 0 - X	2403-208603	89536	2403-208603	1		
11	Dial, 0 - 9	2403-208587	89536	2403-208587	3		
12	Foot, rubber (not illustrated)	2819-103309	77969	9102-W	4		
13	Heat sink, resistor	3156-217463	89536	3156-217463	1		
14	Knob, INTERNAL FUNCTION	2405-170050	89536	2405-170050	1		
15	Panel, rear	3156-217075	89536	3156-217075	1		

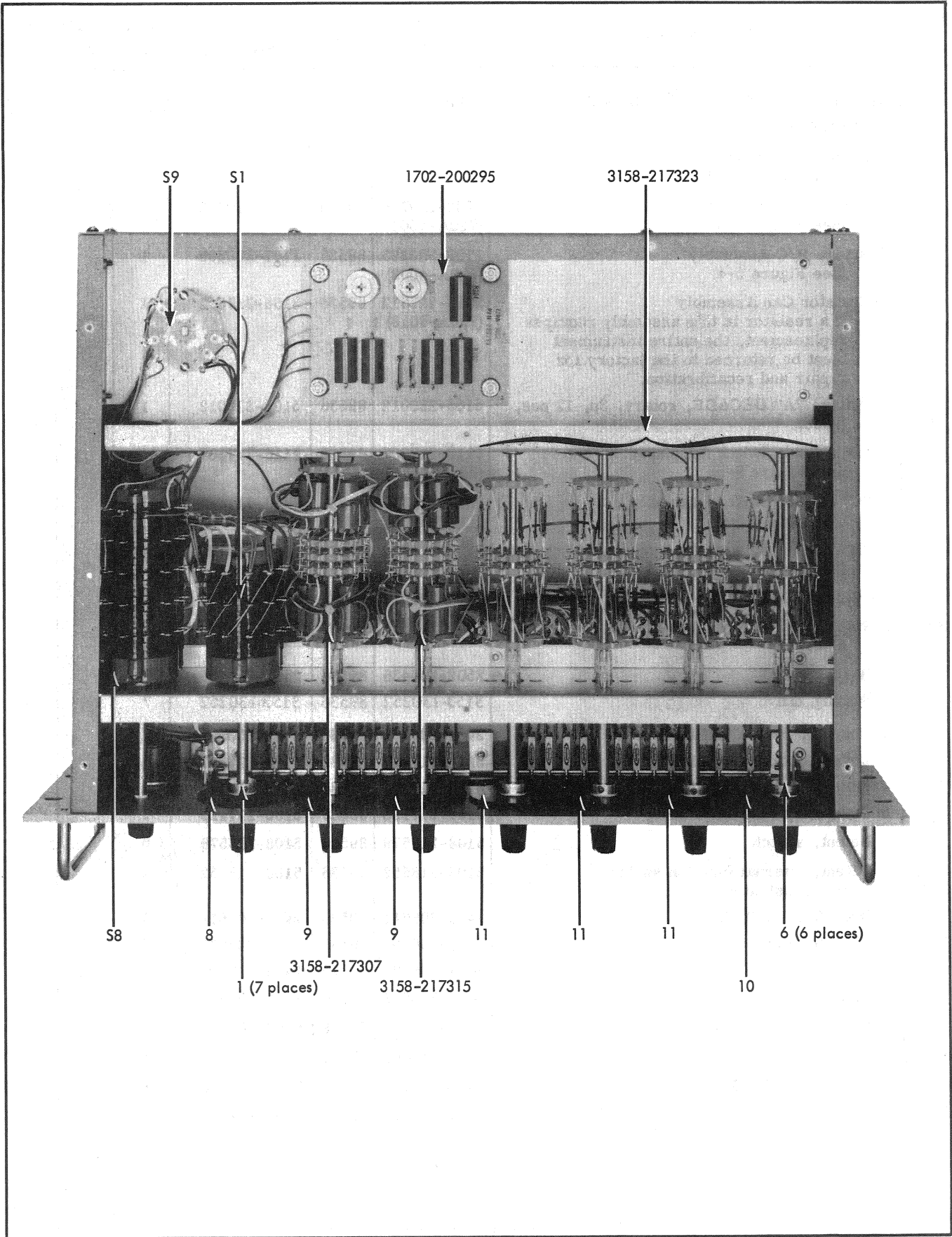

Figure 5-1. 720A KELVIN-VARLEY VOLTAGE DIVIDER (Sheet 1 of 2)

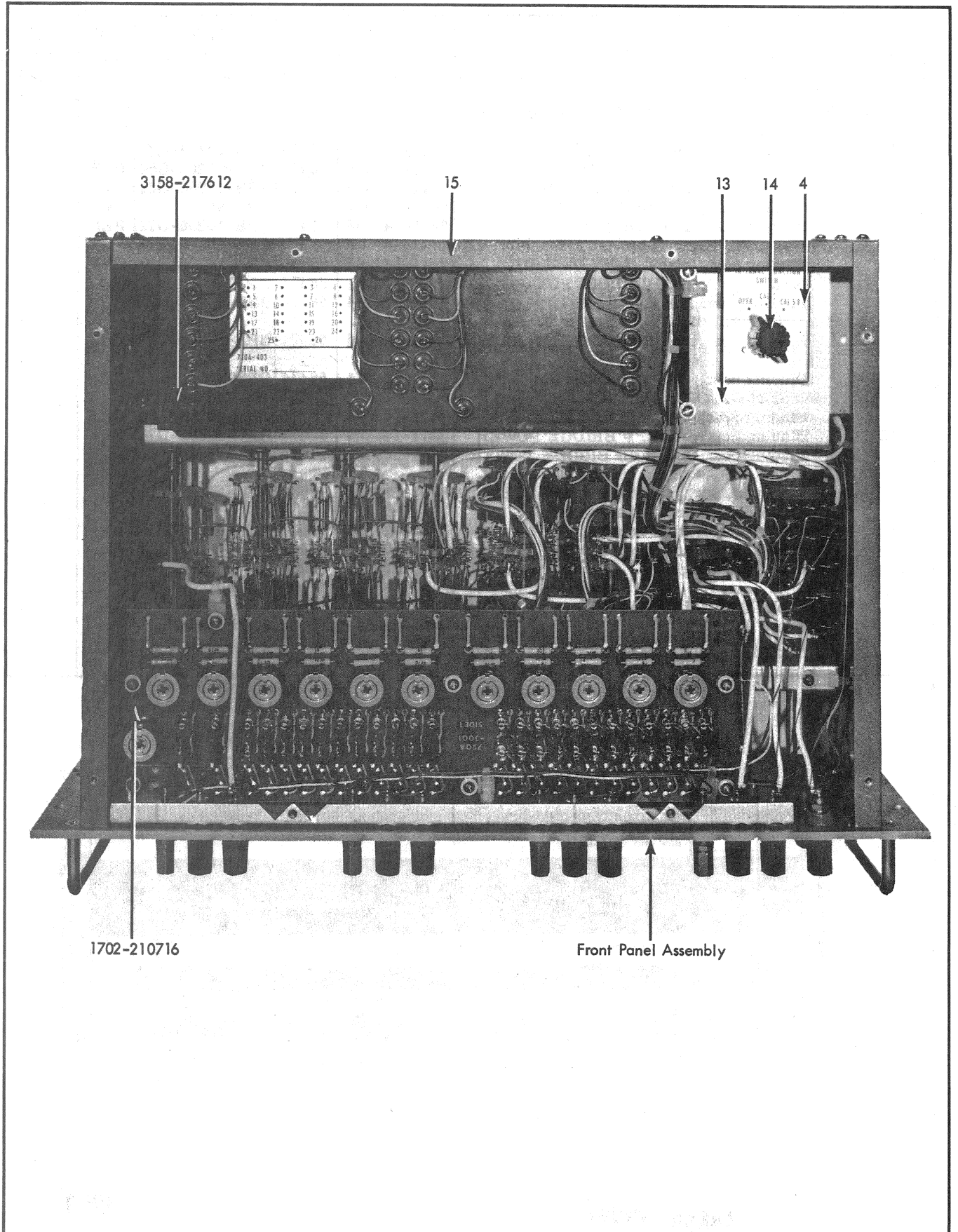

Figure 5-1. 720A KELVIN-VARLEY VOLTAGE DIVIDER (Sheet 2 of 2)

REF DESIG	DESCRIPTION	STOCK NO	MFR	MFR PART NO	TOT QTY	REC QTY	USE CODE
<b>FRONT PANEL ASSEMBLY - Figure 5-2</b>							
J1	Binding post, red, 1.1 INPUT	2811-149856	58474	BHB-10208-G22	5		
J2	Binding post, red, 1.0 INPUT	2811-149856	58474	BHB-10208-G22	REF		
J3	Binding post, black, LOW INPUT	2811-149864	58474	BHB-10208-G21	4		
J4	Binding post, GROUND INPUT	2811-155911	58474	GP30NC	4		
J5	Binding post, red, HIGH OUTPUT	2811-149856	58474	BHB-10208-G22	REF		
J6	Binding post, black, LOW OUTPUT	2811-149864	58474	BHB-10208-G21	REF		
J7	Binding post, GROUND OUTPUT	2811-155911	58474	GP30NC	REF		
J8	Binding post, black, - BRIDGE DETECTOR	2811-149864	58474	BHB-10208-G21	REF		
J9	Binding post, red, + BRIDGE DETECTOR	2811-149856	58474	BHB-10208-G22	REF		
J10	Binding post, GROUND BRIDGE DETECTOR	2811-155911	58474	GP30NC	REF		
J11	Binding post, red, + BRIDGE POWER	2811-149856	58474	BHB-10208-G22	REF		
J12	Binding post, black, - BRIDGE POWER	2811-149864	58474	BHB-10208-G21	REF		
J13	Binding post, GROUND BRIDGE POWER	2811-155911	58474	GP30NC	REF		
R1	Res, var, ww, 5k $\pm$ 3%, 3w, BRIDGE BALANCE (not illustrated)	4702-215319	89536	4702-215319	1		
16	Cover, calibration access	3156-217083	89536	3156-217083	1		
17	Handle, chrome-plated brass	2404-101683	15849	1010-13	2		
18	Knob, A through G	2405-158949	89536	2405-158949	7		
19	Knob, BRIDGE BALANCE	2405-158956	89536	2405-158956	1		
20	Knob, FUNCTION	2405-190249	89536	2405-190249	1		
21	Panel, front	1406-217042	89536	1406-217042	1		

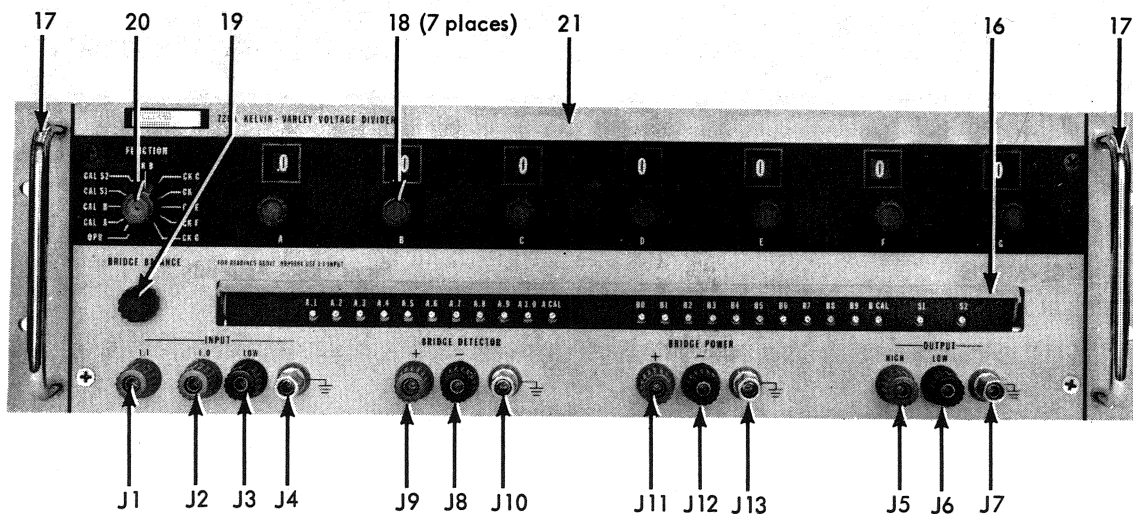















Figure 5-2. FRONT PANEL ASSEMBLY



REF DESIG	DESCRIPTION	STOCK NO	MFR	MFR PART NO	TOT QTY	REC QTY	USE CODE
	<b>TRIMMER P/C ASSEMBLY -Figure 5-3</b>	1702-210716 (720A-4001)	89536	1702-210716	REF		
R1001	Res, var, ww, 5k $\pm$ 10%, 1w	4702-215269	02660	3800P-502	24		
R1002	Res, met flm, 8.45k $\pm$ 1%, 1/2w	4705-159475	12400	Type CEC-TO	12		
R1003	Res, ww, 100 $\Omega$ $\pm$ 0.5%, 1/2w	4707-155846	89536	4707-155846	23	1	
R1004	Res, ww, factory selected						
R1005	Res, var, ww, 5k $\pm$ 10%, 1w	4702-215269	02660	3800P-502	REF		
R1006	Res, met flm, 8.45k $\pm$ 1%, 1/2w	4705-159475	12400	Type CEC-TO	REF		
R1007	Res, ww, 100 $\Omega$ $\pm$ 0.5%, 1/2w	4707-155846	89536	4707-155846	REF		
R1008	Res, ww, factory selected						
R1009	Res, var, ww, 5k $\pm$ 10%, 1w	4702-215269	02660	3800P-502	REF		
R1010	Res, met flm, 8.45k $\pm$ 1%, 1/2w	4702-159475	12400	Type CEC-TO	REF		
R1011	Res, ww, 100 $\Omega$ $\pm$ 0.5%, 1/2w	4707-155846	89536	4707-155846	REF		
R1012	Res, ww, factory selected						
R1013	Res, var, ww, 5k $\pm$ 10%, 1w	4702-215269	02660	3800P-502	REF		
R1014	Res, met flm, 8.45k $\pm$ 1%, 1/2w	4705-159475	12400	Type CEC-TO	REF		
R1015	Res, ww, 100 $\Omega$ $\pm$ 0.5%, 1/2w	4707-155846	89536	4707-155846	REF		
R1016	Res, ww, factory selected						
R1017	Res, var, ww, 5k $\pm$ 10%, 1w	4702-215269	02660	3800P-502	REF		
R1018	Res, met flm, 8.45k $\pm$ 1%, 1/2w	4705-159475	12400	Type CEC-TO	REF		
R1019	Res, ww, 100 $\Omega$ $\pm$ 0.5%, 1/2w	4707-155846	89536	4707-155846	REF		
R1020	Res, ww, factory selected						
R1021	Res, var, ww, 5k $\pm$ 10%, 1w	4702-215269	02660	3800P-502	REF		
R1022	Res, met flm, 8.45k $\pm$ 1%, 1/2w	4705-159475	12400	Type CEC-TO	REF		
R1023	Res, ww, 100 $\Omega$ $\pm$ 0.5%, 1/2w	4707-155846	89536	4707-155846	REF		
R1024	Res, ww, factory selected						
R1025	Res, var, ww, 5k $\pm$ 10%, 1w	4702-215269	02660	3800P-502	REF		
R1026	Res, met flm, 8.45k $\pm$ 1%, 1/2w	4705-159475	12400	Type CEC-TO	REF		
R1027	Res, ww, 100 $\Omega$ $\pm$ 0.5%, 1/2w	4707-155846	89536	4707-155846	REF		
R1028	Res, ww, factory selected						
R1029	Res, var, ww, 5k $\pm$ 10%, 1w	4702-215269	02660	3800P-502	REF		
R1030	Res, met flm, 8.45k $\pm$ 1%, 1/2w	4705-159475	12400	Type CEC-TO	REF		
R1031	Res, ww, 100 $\Omega$ $\pm$ 0.5%, 1/2w	4707-155846	89536	4707-155846	REF		
R1032	Res, ww, factory selected						
R1033	Res, var, ww, 5k $\pm$ 10%, 1w	4702-215269	02660	3800P-502	REF		
R1034	Res, met flm, 8.45k $\pm$ 1%, 1/2w	4705-159475	12400	Type CEC-TO	REF		
R1035	Res, ww, 100 $\Omega$ $\pm$ 0.5%, 1/2w	4707-155846	89536	4707-155846	REF		
R1036	Res, ww, factory selected						
R1037	Res, var, ww, 5k $\pm$ 10%, 1w	4702-215269	02660	3800P-502	REF		
R1038	Res, met flm, 8.45k $\pm$ 1%, 1/2w	4705-159475	12400	Type CEC-TO	REF		
R1039	Res, ww, 100 $\Omega$ $\pm$ 0.5%, 1/2w	4707-155846	89536	4707-155846	REF		
R1040	Res, ww, factory selected						
R1041	Res, var, ww, 5k $\pm$ 10%, 1w	4702-215269	02660	3800P-502	REF		
R1042	Res, met flm, 8.45k $\pm$ 1%, 1/2w	4705-159475	12400	Type CEC-TO	REF		
R1043	Res, ww, 100 $\Omega$ $\pm$ 0.5%, 1/2w	4707-155846	89536	4707-155846	REF		
R1044	Res, ww, factory selected						
R1045	Res, ww, 100 $\Omega$ $\pm$ 0.5%, 1/2w	4707-155846	89536	4707-155846	REF		
R1046	Res, ww, factory selected						
R1047	Res, ww, factory selected						
R1048	Res, var, ww, 5k $\pm$ 10%, 1w	4702-215269	02660	3800P-502	REF		

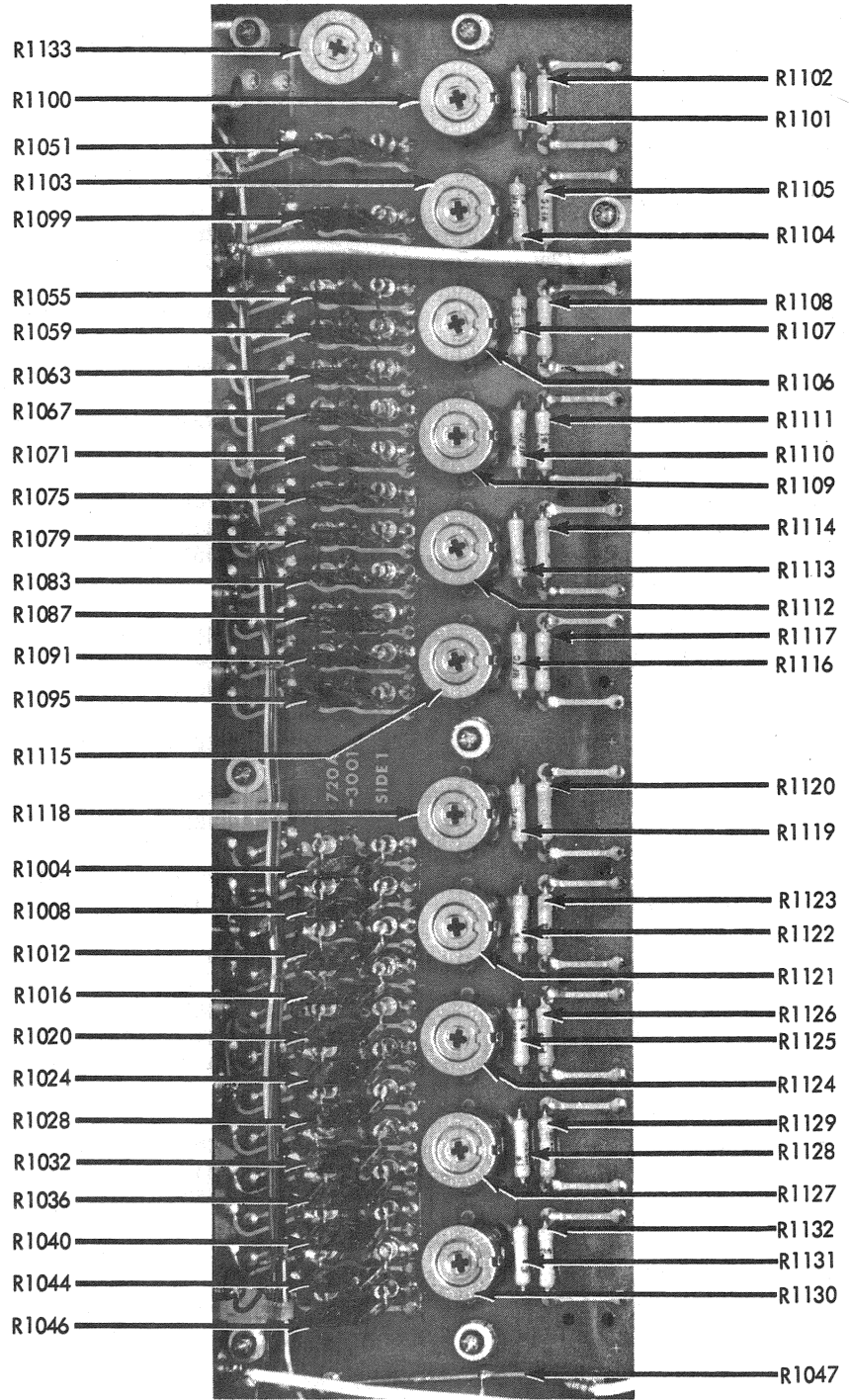

Figure 5-3. TRIMMER P/C ASSEMBLY (Sheet 1 of 2)

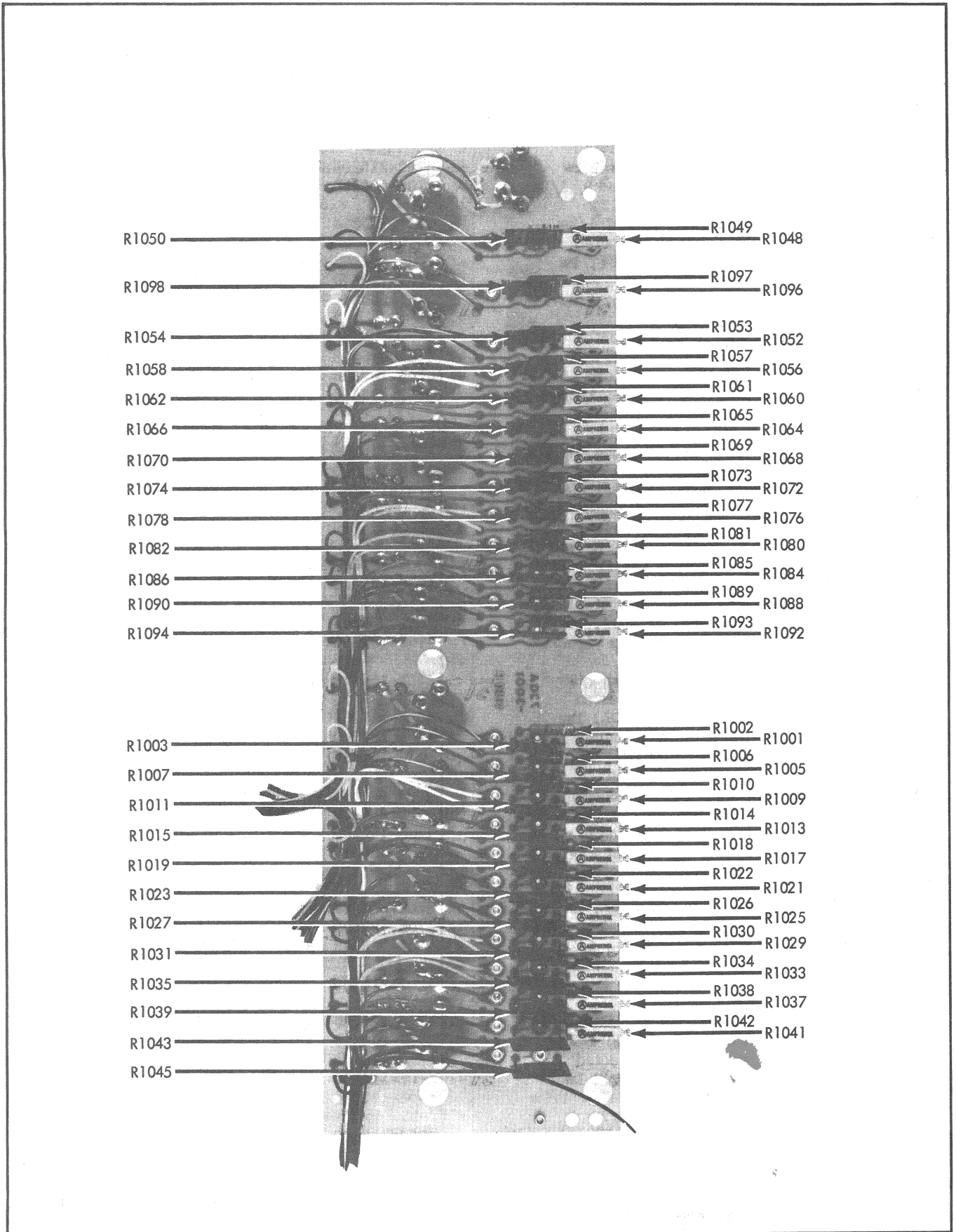







Figure 5-3. TRIMMER P/C ASSEMBLY (Sheet 2 of 2)

REF DESIG	DESCRIPTION	STOCK NO	MFR	MFR PART NO	TOT QTY	REC QTY	USE CODE
R1049	Res, met flm, 8.45k ±1%, 1/2w	4705-159475	12400	Type CEC-TO	REF		
R1050	Res, ww, 250Ω ±0.5%, 1/2w	4707-199893	89536	4707-199893	1	1	
R1051	Res, ww, factory selected	1					
R1052	Res, var, ww, 5k ±10%, 1w	4702-215269	02660	3800P-502	REF		
R1053	Res, met flm, 4.75k ±1%, 1/2w	4705-192500	12400	Type CEC-TO	12		
R1054	Res, ww, 100Ω ±0.5%, 1/2w	4707-155846	89536	4707-155846	REF		
R1055	Res, ww, factory selected	1					
R1056	Res, var, ww, 5k ±10%, 1w	4702-215269	02660	3800P-502	REF		
R1057	Res, met flm, 4.75k ±1%, 1/2w	4705-192500	12400	Type CEC-TO	REF		
R1058	Res, ww, 100Ω ±0.5%, 1/2w	4707-155846	89536	4707-155846	REF		
R1059	Res, ww, factory selected	1					
R1060	Res, var, ww, 5k ±10%, 1w	4702-215269	02660	3800P-502	REF		
R1061	Res, met flm, 4.75k ±1%, 1/2w	4705-192500	12400	Type CEC-TO	REF		
R1062	Res, ww, 100Ω ±0.5%, 1/2w	4707-155846	89536	4707-155846	REF		
R1063	Res, ww, factory selected	1					
R1064	Res, var, ww, 5k ±10%, 1w	4702-215269	02660	3800P-502	REF		
R1065	Res, met flm, 4.75k ±1%, 1/2w	4705-192500	12400	Type CEC-TO	REF		
R1066	Res, ww, 100Ω ±0.5%, 1/2w	4707-155846	89536	4707-155846	REF		
R1067	Res, ww, factory selected	1					
R1068	Res, var, ww, 5k ±10%, 1w	4702-215269	02660	3800P-502	REF		
R1069	Res, met flm, 4.75k ±1%, 1/2w	4705-192500	12400	Type CEC-TO	REF		
R1070	Res, ww, 100Ω ±0.5%, 1/2w	4707-155846	89536	4707-155846	REF		
R1071	Res, ww, factory selected	1					
R1072	Res, var, ww, 5k ±10%, 1w	4702-215269	02660	3800P-502	REF		
R1073	Res, met flm, 4.75k ±1%, 1/2w	4705-192500	12400	Type CEC-TO	REF		
R1074	Res, ww, 100Ω ±0.5%, 1/2w	4707-155846	89536	4707-155846	REF		
R1075	Res, ww, factory selected	1					
R1076	Res, var, ww, 5k ±10%, 1w	4702-215269	02660	3800P-502	REF		
R1077	Res, met flm, 4.75k ±1%, 1/2w	4705-192500	12400	Type CEC-TO	REF		
R1078	Res, ww, 100Ω ±0.5%, 1/2w	4707-155846	89536	4707-155846	REF		
R1079	Res, ww, factory selected	1					
R1080	Res, var, ww, 5k ±10%, 1w	4702-215269	02660	3800P-502	REF		
R1081	Res, met flm, 4.75k ±1%, 1/2w	4705-192500	12400	Type CEC-TO	REF		
R1082	Res, ww, 100Ω ±0.5%, 1/2w	4707-155846	89536	4707-155846	REF		
R1083	Res, ww, factory selected	1					
R1084	Res, var, ww, 5k ±10%, 1w	4702-215269	02660	3800P-502	REF		
R1085	Res, met flm, 4.75k ±1%, 1/2w	4705-192500	12400	Type CEC-TO	REF		
R1086	Res, ww, 100Ω ±0.5%, 1/2w	4707-155846	89536	4707-155846	REF		
R1087	Res, ww, factory selected	1					
R1088	Res, var, ww, 5k ±10%, 1w	4702-215269	02660	3800P-502	REF		
R1089	Res, met flm, 4.75k ±1%, 1/2w	4705-192500	12400	Type CEC-TO	REF		
R1090	Res, ww, 100Ω ±0.5%, 1/2w	4707-155846	89536	4707-155846	REF		
R1091	Res, ww, factory selected	1					
R1092	Res, var, ww, 5k ±10%, 1w	4702-215269	02660	3800P-502	REF		
R1093	Res, met flm, 4.75k ±1%, 1/2w	4705-192500	12400	Type CEC-TO	REF		
R1094	Res, ww, 100Ω ±0.5%, 1/2w	4707-155846	89536	4707-155846	REF		
R1095	Res, ww, factory selected	1					
R1096	Res, var, ww, 5k ±10%, 1w	4702-215269	02660	3800P-502	REF		
R1097	Res, met flm, 4.75k ±1%, 1/2w	4705-192500	12400	Type CEC-TO	REF		
R1098	Res, ww, 400Ω ±0.25%, 1/2w	4707-131698	89536	4707-131698	1		

REF DESIG	DESCRIPTION	STOCK NO	MFR	MFR PART NO	TOT QTY	REC QTY	USE CODE
R1099	Res, ww, factory selected						
R1100	Res, var, ww, 25Ω ±10%, 1 1/4w	4702-161703	71450	Type 110	11		
R1101	Res, met flm, 23. 2Ω ±1%, 1/2w	4705-200790	12400	Type CEC-TO	11		
R1102	Res, met flm, 10Ω ±1%, 1/2w	4705-151043	12400	Type CEC-TO	11		
R1103	Res, var, ww, 25Ω ±10%, 1 1/4w	4702-161703	71450	Type 110	REF		
R1104	Res, met flm, 23. 2Ω ±1%, 1/2w	4705-200790	12400	Type CEC-TO	REF		
R1105	Res, met flm, 10Ω ±1%, 1/2w	4705-151043	12400	Type CEC-TO	REF		
R1106	Res, var, ww, 25Ω ±10%, 1 1/4w	4702-161703	71450	Type 110	REF		
R1107	Res, met flm, 23. 2Ω ±1%, 1/2w	4705-200790	12400	Type CEC-TO	REF		
R1108	Res, met flm, 10Ω ±1%, 1/2w	4705-151043	12400	Type CEC-TO	REF		
R1109	Res, var, ww, 25Ω ±10%, 1 1/4w	4702-161703	71450	Type 110	REF		
R1110	Res, met flm, 23. 2Ω ±1%, 1/2w	4705-200790	12400	Type CEC-TO	REF		
R1111	Res, met flm, 10Ω ±1%, 1/2w	4705-151043	12400	Type CEC-TO	REF		
R1112	Res, var, ww, 25Ω ±10%, 1 1/4w	4702-161703	71450	Type 110	REF		
R1113	Res, met flm, 23. 2Ω ±1%, 1/2w	4705-200790	12400	Type CEC-TO	REF		
R1114	Res, met flm, 10Ω ±1%, 1/2w	4705-151043	12400	Type CEC-TO	REF		
R1115	Res, var, ww, 25Ω ±10%, 1 1/4w	4702-161703	71450	Type 110	REF		
R1116	Res, met flm, 23. 2Ω ±1%, 1/2w	4705-200790	12400	Type CEC-TO	REF		
R1117	Res, met flm, 10Ω ±1%, 1/2w	4705-151043	12400	Type CEC-TO	REF		
R1118	Res, var, ww, 25Ω ±10%, 1 1/4w	4702-161703	71450	Type 110	REF		
R1119	Res, met flm, 23. 2Ω ±1%, 1/2w	4705-200790	12400	Type CEC-TO	REF		
R1120	Res, met flm, 10Ω ±1%, 1/2w	4705-151043	12400	Type CEC-TO	REF		
R1121	Res, var, ww, 25Ω ±10%, 1 1/4w	4702-161703	71450	Type 110	REF		
R1122	Res, met flm, 23. 2Ω ±1%, 1/2w	4705-200790	12400	Type CEC-TO	REF		
R1123	Res, met flm, 10Ω ±1%, 1/2w	4705-151043	12400	Type CEC-TO	REF		
R1124	Res, var, ww, 25Ω ±10%, 1 1/4w	4702-161703	71450	Type 110	REF		
R1125	Res, met flm, 23. 2Ω ±1%, 1/2w	4705-200790	12400	Type CEC-TO	REF		
R1126	Res, met flm, 10Ω ±1%, 1/2w	4705-151043	12400	Type CEC-TO	REF		
R1127	Res, var, ww, 25Ω ±10%, 1 1/4w	4702-161703	71450	Type 110	REF		
R1128	Res, met flm, 23. 2Ω ±1%, 1/2w	4705-200790	12400	Type CEC-TO	REF		
R1129	Res, met flm, 10Ω ±1%, 1/2w	4705-151043	12400	Type CEC-TO	REF		
R1130	Res, var, ww, 25Ω ±10%, 1 1/4w	4702-161703	71450	Type 110	REF		
R1131	Res, met flm, 23. 2Ω ±1%, 1/2w	4705-200790	12400	Type CEC-TO	REF		
R1132	Res, met flm, 10Ω ±1%, 1/2w	4705-151043	12400	Type CEC-TO	REF		
R1133	Res, var, ww, 150Ω ±20%, 1 1/4w	4702-163642	71450	Type 110	1		



These resistors are factory selected. Replace with exact value. When ordering, include model, serial number, reference designation and all information stamped on the resistor.

REF DESIG	DESCRIPTION	STOCK NO	MFR	MFR PART NO	TOT QTY	REC QTY	USE CODE
	<b>BRIDGE P/C ASSEMBLY - Figure 5-4</b>	1702-200295 (720A-4002)	89536	1702-200295	REF		
R201	Res, ww, 39.536k, matched set						
R202	Res, ww, 39.536k, matched set						
R203	Res, var, ww, 100Ω ±20%, 1 1/4w	4702-112797	71450	Type 110	2		
R204	Res, ww, 15.814k ±0.02%, 1w	4707-200550	89536	4707-200550	1	1	
R205	Res, var, ww, 100Ω ±20%, 1 1/4w	4702-112797	71450	Type 110	REF		
R206	Res, ww, 4.873k, matched set						
R207	Res, ww, 4.873k, matched set						
R208	Res, met flm, 15k ±1%, 1/2w	4705-151498	12400	Type CEC-TO	1		
R209	Res, ww, 250Ω ±0.5%, 1/2w	4707-199893	89536	4707-199893	1	1	



These resistors are factory matched. If replacement is required, an entire set, part number 4710-217679, must be ordered.



These resistors are factory matched. If replacement is required, an entire set, part number 4710-217687, must be ordered.

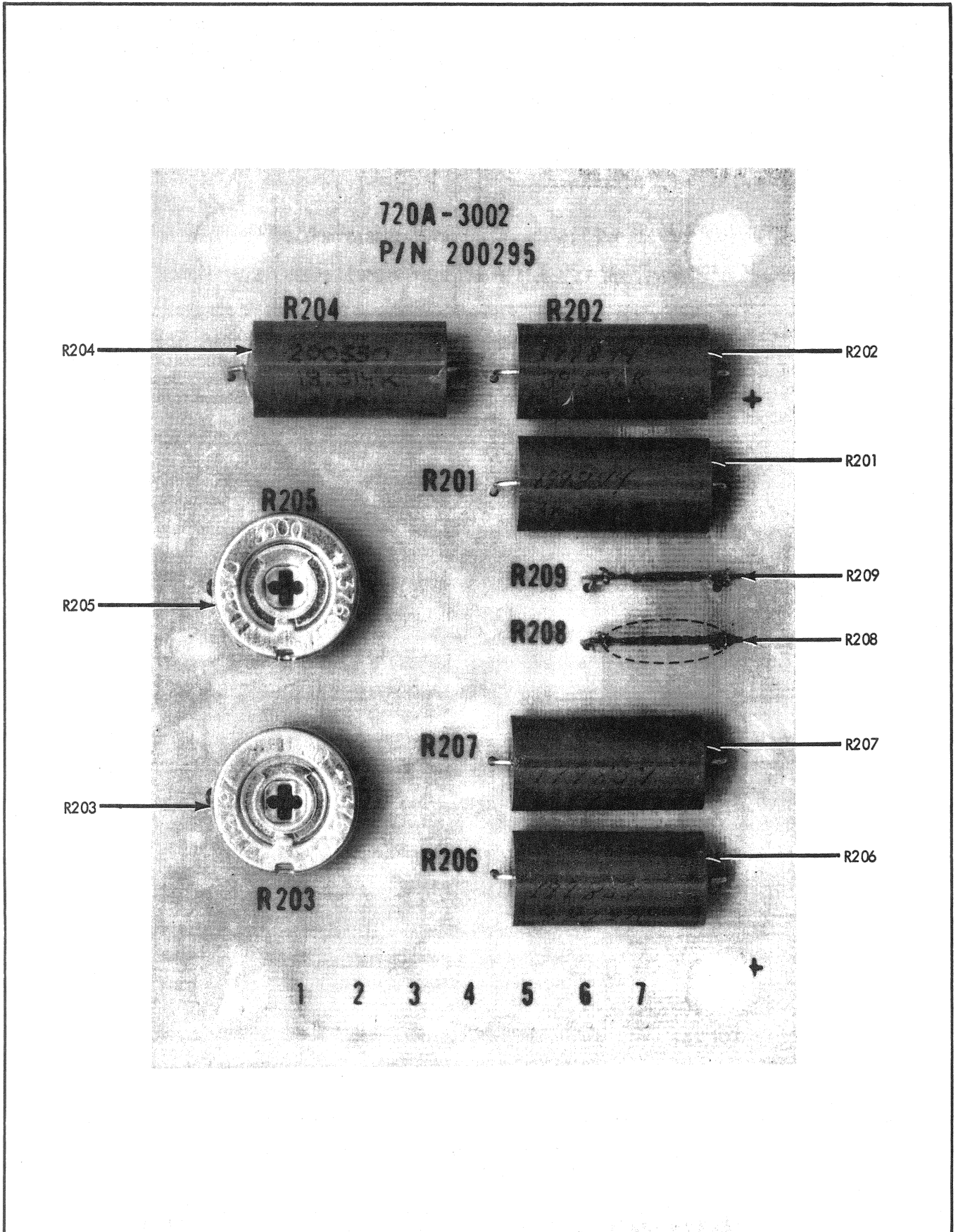

Figure 5-4. BRIDGE P/C ASSEMBLY

REF DESIG	DESCRIPTION	STOCK NO	MFR	MFR PART NO	TOT QTY	REC QTY	USE CODE
R401 thru R411	"B" DECADE SWITCH ASSEMBLY Figure 5-5  Res, ww, 9.898k, matched set	5110-217307 (720A-4004)	89536	5110-217307	REF		
R412	Res, ww, 39.536k ±0.01%, 1w	4707-199810	89536	4707-199810	1	1	
S2	Switch, "B", rotary, 3p, 11 pos, 5 sect	5107-218602	89536	5107-218602	2		

4 These resistors are a factory matched set, part number 4710-217646. If replacement of one or more resistors in the set is required, include all information stamped on the resistor along with the information described in paragraph 5-6. Should the information on the resistor not be discernible, include all of the above information about the adjacent resistors.

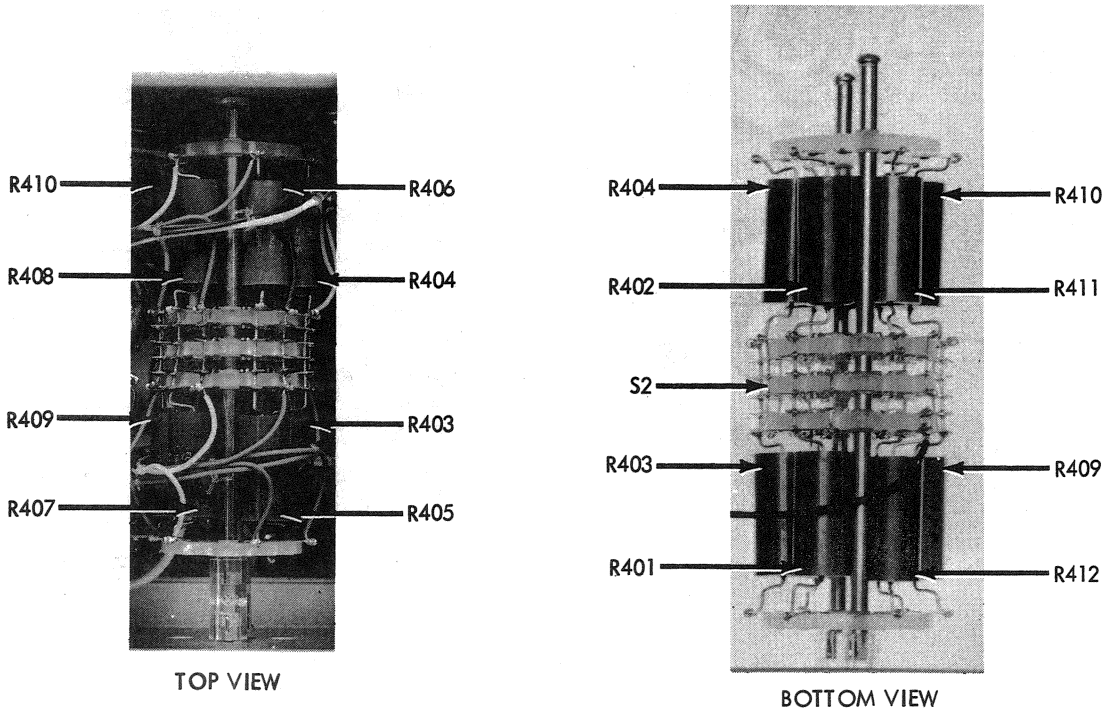

Figure 5-5. "B" DECADE SWITCH ASSEMBLY



REF DESIG	DESCRIPTION	STOCK NO	MFR	MFR PART NO	TOT QTY	REC QTY	USE CODE
R501 thru R511	"C" DECADE SWITCH ASSEMBLY Figure 5-6  Res, ww, 4k, matched set	5110-217315 (720A-4005)	89536	5110-217315	REF		
R512	Res, ww, 40.31k $\pm$ 0.02%, 1w	4707-199836	89536	4707-199836	1	1	
S3	Switch, "C", rotary, 3p, 11 pos, 5 sect	5107-218602	89536	5107-218602	REF		

5 These resistors are a factory matched set, part number 4710-217653. If replacement of one or more resistors in the set is required, include all information stamped on the resistor along with the information described in paragraph 5-6. Should the information on the resistor not be discernible, include all of the above information about the adjacent resistors.

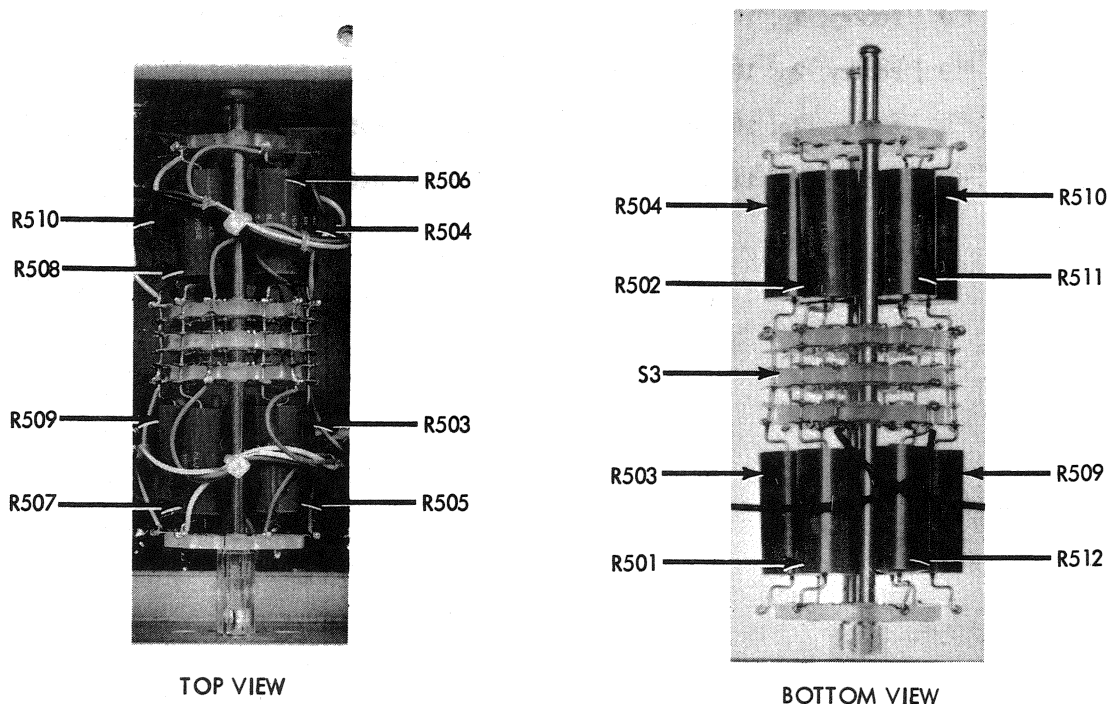









Figure 5-6. "C" DECADE SWITCH ASSEMBLY

REF DESIG	DESCRIPTION	STOCK NO	MFR	MFR PART NO	TOT QTY	REC QTY	USE CODE
	<b>"D", "E", "F", AND "G" DECADES SWITCH ASSEMBLY - Figure 5-7</b>	5110-217323 (720A-4006)	89536	5110-217323	REF		
R601 thru R611	Res, ww, 1k, matched set						
R612	Res, ww, 2.5k, matched set						
R701 thru R711	Res, ww, 1k, matched set						
R712	Res, ww, 2.5k, matched set						
R801 thru R811	Res, ww, 1k, matched set						
R812	Res, ww, 2.5k, matched set						
R901 thru R910	Res, ww, 1k, matched set						
S4	Switch, "D", rotary, 2p, 10 pos, 4 sect	5107-218594	89536	5107-218594	3		
S5	Switch, "E", rotary, 2p, 10 pos, 4 sect	5107-218594	89536	5107-218594	REF		
S6	Switch, "F", rotary, 2p, 10 pos, 4 sect	5107-218594	89536	5107-218594	REF		
S7	Switch, "G", rotary, 1p, 11 pos, 3 sect	5107-218586	89536	5107-218586	1		



These resistors are a factory matched set, part number 4710-217661. If replacement of one or more resistors in the set is required, include all information stamped on the resistor along with the information described in paragraph 5-6. Should the information on the resistor not be discernible, include all of the above information about the adjacent resistors.

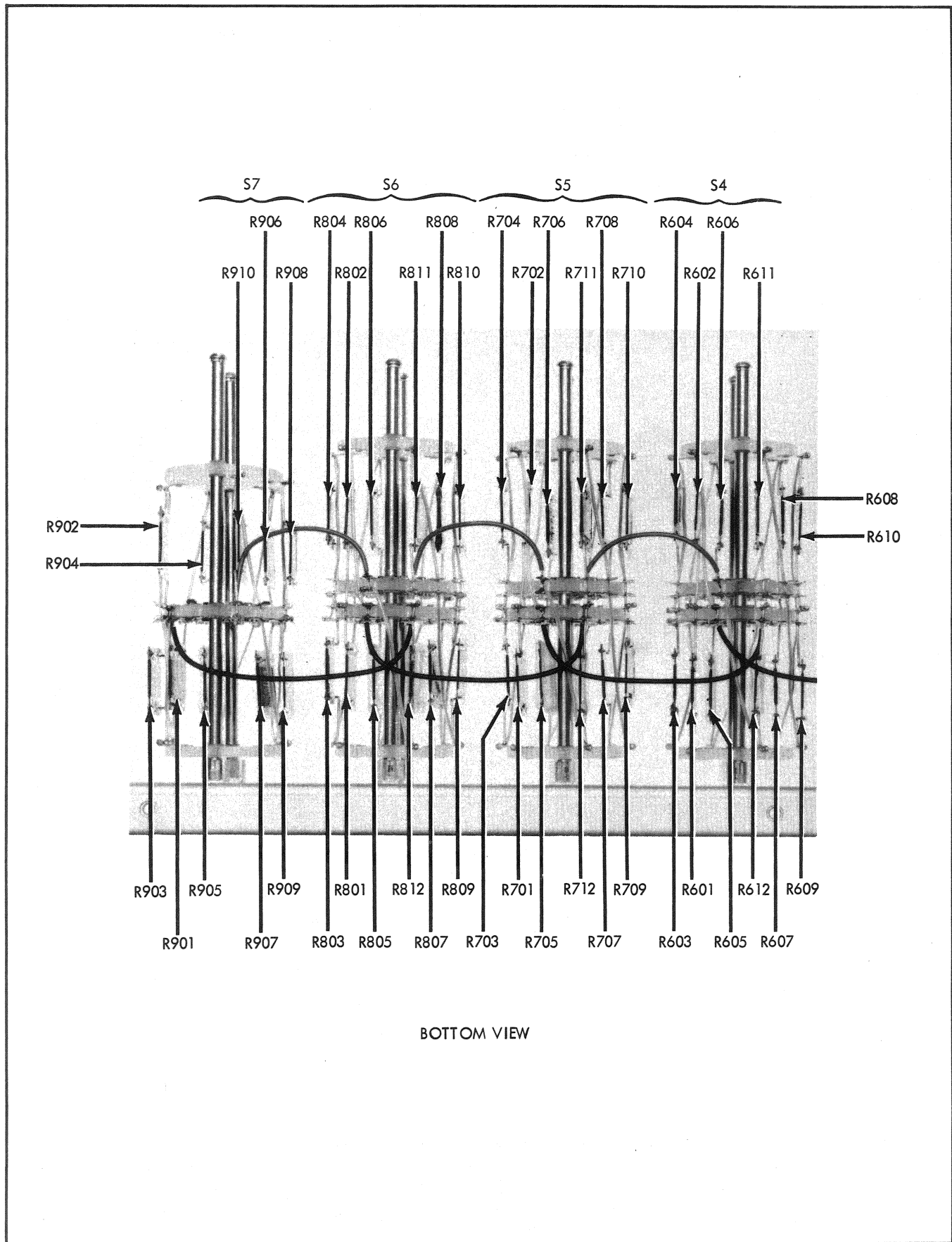

Figure 5-7. "D", "E", "F" AND "G" DECADES SWITCH ASSEMBLY

## Section 7

# General Information

7-1. This section of the manual contains generalized user information as well as supplemental information to the List of Replaceable Parts contained in Section 5.

## Federal Supply Codes for Manufacturers

<p>D9816 Westermann Wilhelm Augusta-Anlage Mannheim-Nackarau Germany</p>	<p>01101 Wabash Inc (Formerly Wabash Magnetics) Wabash, IN</p>	<p>02697 Parker-Hannifin Corp. O-Ring Div Lexington, KY</p>	<p>04423 Telonic Berkley Inc. Laguna Beach, CA</p>
<p>S0482 Sony Corp. Tokyo, Japan</p>	<p>01121 Allen Bradley Co. Milwaukee, WI</p>	<p>02735 RCA-Solid State Div. Somerville, NJ</p>	<p>04713 Motorola Inc. Semiconductor Group Phoenix, AZ</p>
<p>S3774 Oshino Electric Lamp Works Tokoyo, Japan</p>	<p>01281 TRW Electronics &amp; Defense Sector R F Devices Lawndale, CA</p>	<p>02768 ITW (IL Tool Works) Fastex Division Des Plaines, IL</p>	<p>04946 Standard Wire and Cable Rancho Dominguez, CA</p>
<p>0AD86 IN General El Paso, TX</p>	<p>01295 TX Instruments Inc. Semiconductor Group Dallas, TX</p>	<p>02799 Arco Electronics Inc. Chatsworth, CA</p>	<p>05173 General Radio NY,NY. Replaced by:</p>
<p>0AE89 Autosplice Inc. Woodside, NY</p>	<p>01526 Genicom Waynesboro, VA</p>	<p>03296 Nylon Molding Corp. Monrovia, CA</p>	<p>24655 Genrad,INC. Concord, MA</p>
<p>0BW21 Noritake Co. Inc. Burlington, MA</p>	<p>01537 Motorola Communications &amp; Electronics Inc. Franklin Park, IL</p>	<p>03445 Lercon Electronics Inc Burbank, CA</p>	<p>05236 Jonathan Mfg. Co. Fullerton, CA</p>
<p>0ANF0 Topaz Semiconductor Inc San Jose, CA</p>	<p>01686 RCL Electronics/Shallcross Inc. Electro Components Div. Manchester, NH</p>	<p>03508 General Electric Co. Semiconductor Products &amp; Batteries Auburn, NY</p>	<p>05245 Corcom Inc. Libertyville, IL</p>
<p>0DSM7 Conductive (Pkg) Containers Inc. Brookfield, WI</p>	<p>01884 Sprague Electric Co. (Now 56289)</p>	<p>03797 Genisco Technology Corp. Eltronics Div. Rancho Dominguez, CA</p>	<p>05276 ITT Pomona Electronics Div. Pomona, CA</p>
<p>0CLN7 Emhart Fastening Group Shelton, CT</p>	<p>01961 Varian Associates Inc. Pulse Engineering Div. Convoy, CT</p>	<p>03877 Gilbert Engineering Co.Inc Incon Sub of Transित्रon Electronic Corp. Glendale, AZ</p>	<p>05277 Westinghouse Elec. Corp. Semiconductor Div. Youngwood, PA</p>
<p>0FB81 S-Mos Systems Inc. San Jose, CA</p>	<p>01963 Cherry Electrical Products Corp Waukegan, IL</p>	<p>03888 KDI Electronics Inc. Pyrofilm Div. Whippany, NJ</p>	<p>05347 Ultronix Inc Grand Junction, CO</p>
<p>0FFP1 Eveready LTD Ever Ready Special Battery Div. Dawley Telford Salop UK</p>	<p>02111 Spectrol Electronics Corp. City of Industry, CA</p>	<p>03911 Clairex Corp. Clairex Electronics Div. Mount Vernon, NY</p>	<p>05397 Union Carbide Corp. Materials Systems Div. Cleveland, OH</p>
<p>00199 Marcon Electronics Corp Keamy, NJ</p>	<p>02114 Ampere Electronic Corp. Ferrox Cube Div. Saugerties, NY</p>	<p>03980 Muirhead Inc. Mountainside, NJ</p>	<p>05571 Sprague Electric Co. (Now 56289)</p>
<p>00213 Nytronics Comp. Group Inc. Darlington, NC</p>	<p>02131 General Instrument Corp. Government Systems Div. Westwood, MA</p>	<p>04009 Cooper Industries, Inc. Arrow Hart Div. Hartford, CT</p>	<p>05574 Viking Connectors Inc Sub of Criton Corp. Chatsworth, CA</p>
<p>00327 Welwyn International Inc. Westlake, OH</p>	<p>02395 Sonar Radio Corp. Hollywood, FL</p>	<p>04217 Essex International Inc. Wire &amp; Cable Div. Anaheim, CA</p>	<p>05791 LYN-TRON Burbank, CA</p>
<p>00656 Aerovox Corp. New Bedford, MA</p>	<p>02533 Leigh Instruments Ltd. Frequency Control Div. Don Mills, Ontario, Canada</p>	<p>04221 Midland-Ross Corp. Midtex Div. N. Mankato, MN</p>	<p>05820 EG &amp; G Wakefield Engineering Wakefield, MA</p>
<p>00686 Film Capacitors Inc. Passaic, NJ</p>	<p>02606 Fenwal Labs Division of Travenal Labs Morton Grove, IL</p>	<p>04222 AVX Corp. AVX Ceramics Div. Myrtle Beach, SC</p>	<p>05839 Advance Electrical Chicago, IL</p>
<p>00779 AMP, Inc. Harrisburg, Pennsylvania</p>	<p>02660 Bunker Ramo-Eltra Corp. Amphenol NA Div. Broadview, IL</p>	<p>05972 Loctite Corp. Newington, CT</p>	

## Federal Supply Codes for Manufacturers (cont)

06001 General Electric Co. Electric Capacitor Product Section Columbia, SC	07047 Ross Milton Co., The Southampton, PA	08111 MF Electronics New Rochelle, NY	1B715 (United Shoe & Nylock Corp) -Nylock Fastener Corp.- Paramus, NJ
06141 Fairchild Weston Systems Inc. Data Systems Div. Sarasota, FL	07138 Westinghouse Electric Corp. Industrial & Government Tube Div. Horseheads, NY	08235 Industro Transistor Corp. Long Island City, NY	10059 Barker Engineering Corp. Kenilworth, NJ
06192 La Deau Mfg. Co. Glendale, CA	07233 Benchmark Technology Inc. City of Industry, CA	08261 Spectra-Strip An Eltra Co. Garden Grove, CA	10389 IL Tool Works Inc. Licon Div. Chicago, IL
06229 Electrovert Inc. Elmsford, NY	07239 Biddle Instruments Blue Bell, PA	08445 Electri-Cord Mfg., Inc Westfield, PA	11236 CTS Corp. Resistor Products Div. Beme, IN
06383 Panduit Corp. Tinley Park, IL	07256 Silicon Transistor Corp. Sub of BBF Inc. Chelmsford, MA	08530 Reliance Mica Corp. Brooklyn, NY	11237 CTS Corp of CA Electro Mechanical Div. Paso Robles, CA
06473 Bunker Ramo Corp. Amphenol NA Div. SAMS Operation Chatsworth, CA	07261 Avnet Corp. Culver City, CA	08718 ITT Cannon Electric Phoenix Div. Phoenix, AZ	11295 ECM Motor Co. Schaumburg, IL
06540 Mite Corp Amatom-Electrical Div	07263 Fairchild Semiconductor North American Sales Ridgeview, CT	08806 General Electric Co. Minature Lamp Products Cleveland, OH	11358 Columbia Broadcasting System CBS Electronic Div. Newburyport, MA
06555 Beede Electrical Instrument Penacook, NH	07344 Bircher Co. Inc., The Rochester, NY	08863 Nylomatic Fallsington, PA	11403 Vacuum Can Co. Best Coffee Maker Div. Chicago, IL
06665 Precision Monolithics Sub of Boums Inc. Santa Clara, CA	07374 Optron Corp Woodbridge, CT	08988 Skottie Electronics Inc. Archbald, PA	11502 (can also use 35009) TRW Inc. TRW Resistive Products Div. Boone, NC
06666 General Devices Co. Inc. INpolis, IN	07557 Campion Co. Inc. Philadelphia, PA	09021 Aircor Inc. Aircor Electronics Bradford, PA	11503 Keystone Columbia Inc. Freemont, IN
06739 Electron Corp. Littleton, CO	07597 Bumdy Corp. Tape/Cable Div. Rochester, NY	09023 Cornell-Dublier Electronics Fuquay-Varina, NC	11532 Teledyne Relays Teledyne Industries Inc. Hawthorne, CA
06743 Gould Inc. Foil Div. Eastlake, OH	07716 TRW Inc. (Can use 11502) IRC Fixed Resistors/ Burlington Burlington, VT	09214 General Electric Co. Semiconductor Products Dept. Auburn, NY	11711 General Instrument Corp. Rectifier Div. Hicksville, NY
06751 Components Inc. Sencor Div. Phoenix, AZ	07792 Lerma Engineering Corp. Northampton, MA	09353 C and K Components Inc. Newton, MA	11726 Qualidyne Corp. Santa Clara, CA
06776 Robinson Nugent Inc. New Albany, IN	07810 Bock Corp. Madison, WI	09423 Scientific Components Inc. Santa Barbara, CA	12014 Chicago Rivet & Machine Co. Naperville, IL
06915 Richco Plastic Co. Chicago, IL	07910 Teledyne Semiconductor Mtn. View, CA	09922 Bumdy Corp. Norwalk, CT	12020 Ovenaire Div. of Electronic Technologies Charlottesville, VA
06961 Vernitron Corp. Piezo Electric Div. Bedford, OH	07933 Raytheon Co. Semiconductor Div. Mountain View, CA	09969 Dale Electronics Inc. Yankton, SD	12038 Simco (Div of Ransburg Corp) Hatfield, PA
06980 EIMAC (See Varian) San Carlos, CA	08FG6 Calmos Systems Inc. Kanata, Ont. Canada	09975 Burroughs Corp. Electronics Components Detroit, MI	12040 National Semiconductor Corp. Danbury, CT
	080A9 Dallas Semiconductor Dallas, TX	1A791 LFE Electronics Danvers, MA	

## Federal Supply Codes for Manufacturers (cont)

<p>12060 Diodes Inc. Northridge, CA</p>	<p>13050 Potter Co. Wesson, MS</p>	<p>14704 Crydom Controls (Division of Int Rectifier) El Segundo, CA</p>	<p>16473 Cambridge Scientific Industries Div. of Chemed Corp. Cambridge, MD</p>
<p>12136 PHC Industries Inc. Formerly Philadelphia Handle Co. Camden, NJ</p>	<p>13103 Thermalloy Co., Inc. Dallas, TX</p>	<p>14752 Electro Cube Inc. San Gabriel, CA</p>	<p>16733 Cablewave Systems Inc. North Haven, CT</p>
<p>12300 AMF Canada Ltd. Potter-Brumfield Guelph, Ontario, Canada</p>	<p>13327 Solitron Devices Inc. Tappan, NY</p>	<p>14936 General Instrument Corp. Discrete Semi Conductor Div. Hicksville, NY</p>	<p>16742 Paramount Plastics Fabricators Inc. Downey, CA</p>
<p>12323 Practical Automation Inc. Shelton, CT</p>	<p>13511 Bunker-Ramo Corp. Amphenol Cadre Div. Los Gatos, CA</p>	<p>14949 Trompeter Electronics Chatsworth, CA</p>	<p>16758 General Motors Corp. Delco Electronics Div. Kokomo, IN</p>
<p>12327 Freeway Corp. Cleveland, OH</p>	<p>13606 Sprague Electric Co. (Use 56289)</p>	<p>15412 Amtron Midlothian, IL</p>	<p>17069 Circuit Structures Lab Burbank, CA</p>
<p>12406 Elpac Electronics Inc. Santa Ana, CA</p>	<p>13689 SPS Technologies Inc. Hatfield, NJ</p>	<p>15542 Scientific Components Corp. Mini-Circuits Laboratory Div. Brooklyn, NY</p>	<p>17117 Electronic Molding Corp. Woonsocket, RI</p>
<p>12443 Budd Co.,The Plastics Products Div. Phoenixville, PA</p>	<p>13764 Micro Plastics Flippin, AZ</p>	<p>15636 Elec-Trol Inc. Saugus, CA</p>	<p>17338 High Pressure Eng. Co. Inc. OK City, OK</p>
<p>12581 Hitachi Metals International Ltd. Hitachi Magna-Lock Div. Big Rapids, MO</p>	<p>13919 Burr-Brown Research Corp. Tucson, AZ</p>	<p>15782 Bausch &amp; Lomb Inc. Graphics &amp; Control Div. Austin, TX</p>	<p>17504 Aluminum Filter Co. Carpinteria, CA</p>
<p>12615 US Terminals Inc. Cincinnati, OH</p>	<p>14099 Semtech Corp. Newbury Park, CA</p>	<p>15801 Fenwal Electronics Inc. Div. of Kidde Inc. Framingham, MA</p>	<p>17545 Atlantic Semiconductors Inc. Asbury Park, NJ</p>
<p>12617 Hamlin Inc. LaKe Mills, WI</p>	<p>14140 McGray-Edison Co. Commercial Development Div. Manchester, NH</p>	<p>15818 Teledyne Inc. Co. Teledyne Semiconductor Div. Mountain View, CA</p>	<p>17745 Angstrom Precision, Inc. Hagerstown, MD</p>
<p>12673 Wesco Electrical Greenfield, MA</p>	<p>14189 Ortronics, Inc. Orlando, FL</p>	<p>15849 Useco Inc. (Now 88245)</p>	<p>17856 Siliconix Inc. Santa Clara, CA</p>
<p>12697 Clarostat Mfg. Co. Inc. Dover, NH</p>	<p>14193 Cal-R-Inc. Santa Monica, CA</p>	<p>15898 International Business Machines Corp. Essex Junction, VT</p>	<p>18178 E G &amp; Gvactee Inc. St. Louis, MO</p>
<p>12749 James Electronic Inc. Chicago, IL</p>	<p>14301 Anderson Electronics Hollidaysburg, PA</p>	<p>16068 International Diode Div. Harrison, NJ</p>	<p>18235 KRL/Bantry Components Inc. Manchester, NH</p>
<p>12856 MicroMetals Inc. Anaheim, CA</p>	<p>14329 Wells Electronics Inc. South Bend, IN</p>	<p>16162 MMI Southfield, MI</p>	<p>18310 Concord Electronics New York, NY</p>
<p>12881 Metex Corp. Edison, NJ</p>	<p>14482 Watkins-Johnson Co. Palo Alto, CA</p>	<p>16245 Conap Inc. Olean, NY</p>	<p>18324 Signetics Corp. Sacramento, CA</p>
<p>12895 Cleveland Electric Motor Co. Cleveland, OH</p>	<p>14552 Microsemi Corp. (Formerly Micro-Semiconductor) Santa Ana, CA</p>	<p>16258 Space-Lok Inc. Burbank, CA</p>	<p>18377 Parlex Corp. Methuen, MA</p>
<p>12954 Microsemi Corp. Components Group Scottsdale, AZ</p>	<p>14604 Elmwood Sensors, Inc Pawtucket, RI</p>	<p>16352 Codi Corp. Linden, NJ</p>	<p>18520 Sharp Electronics Corp. Paramus, NJ</p>
<p>12969 Unitrode Corp. Lexington, MA</p>	<p>14655 Cornell-Dublier Electronics Div. of Federal Pacific Electric Co. Govt Cont Dept. Newark, NJ</p>	<p>16469 MCL Inc. LaGrange, IL</p>	<p>18542 Wabash Inc. Wabash Relay &amp; Electronics Div. Wabash, IN</p>

## Federal Supply Codes for Manufacturers (cont)

18565 Chomerics Inc. Woburn, MA	2Y384 North American Philips Lighting Corp. Van Wert, OH	23732 Tracor Applied Sciences Inc. Rockville, MD	26402 Lumex, Inc. Bayshore, NY
18612 Vishay Intertechnology Inc. Vishay Resistor Products Group Malvern, PA	20584 Enochs Mfg. Inc. INpolis, IN	23880 Stanford Applied Engineering Santa Clara, CA	26629 Frequency Sources Inc. Sources Div. Chelmsford, MA
18632 Norton-Chemplast Santa Monica, CA	20891 Cosar Corp. Dallas, TX	23936 William J. Purdy Co. Pamotor Div. Burlingame, CA	26806 American Zettler Inc. Irvine, CA
18677 Scanbe Mfg. Co. Div. of Zero Corp. El Monte, CA	21317 Electronics Applications Co. El Monte, CA	24347 Penn Engineering Co. S. El Monte, CA	27014 National Semiconductor Corp. Santa Clara, CA
18736 Voltronics Corp. East Hanover, NJ	21604 Buckeye Stamping Co. Columbus, OH	24355 Analog Devices Inc. Norwood, MA	27167 Corning Glass Works Corning Electronics Wilmington, NC
18786 Micro-Power Long Island City, NY	21845 Solitron Devices Inc. Semiconductor Group Riviera Beach, FL	24444 General Semiconductor Industries, Inc. Tempe, AZ	27264 Molex Inc. Lisle, IL
18927 GTE Products Corp. Precision Material Products Business Parts Div. Titusville, PA	21847 Aerotech Now TRW Microwave Inc. Sunnyvale, CA	24546 Bradford Electronics Bradford, PA	27440 Industrial Screw Products Los Angeles, CA
19080 Robinson Electronics Inc. San Luis Obispo, CA	21962 Vectron Corp. Replaced by: S.W. Electronics	24618 Transcon Mfg. Now: D.J. Associates Inc.	27494 Staffall, Inc. Providence, RI
19112 Garry Corp. Langhorne, PA	22526 DuPont, El DeNemours & Co. Inc. DuPont Connector Systems Advanced Products Div. New Cumberland, PA	24655 Genrad Inc. (Replaced General Radio 05173) Concord, MA	27745 Associated Spring Bames Group Inc. Syracuse, NY
19315 Bendix Corp., The Navigation & Control Group Terboro, NJ	22626 Micro Semiconductor (Now 14552)	24759 Lenox-Fugle Electronics Inc. South Plainfield, NJ	27918 Component Parts Corp. Bellmore, NY
19451 Perine Machine Tool Corp. Kent, WA	22670 GM Nameplate Seattle, WA	24796 AMF Inc. Potter & Brumfield Div. San Juan Capistrano, CA	27956 Relcom (Now 14482)
19482 Delta Electronics Alexandria, VA	22767 ITT Semiconductors Palo Alto, CA	24931 Specialty Connector Co. Greenwood, IN	28175 Alpha Metals Chicago, IL
19613 MN Mining & Mfg. Co. Textool Products Dept. Electronic Product Div. Irving, TX	22784 Palmer Inc. Cleveland, OH	24995 ECS Grants Pass, OR	28198 Positronic Industries Springfield, MO
19647 Caddock Electronics Inc. Riverside, CA	23050 Product Comp. Corp. Mount Vernon, NY	25088 Siemen Corp. Isilen, NJ	28213 MN Mining & Mfg. Co. Consumer Products Div. 3M Center Saint Paul, MN
19701 Mepco/Centralab Inc. A. N. American Philips Co. Mineral Wells, TX	23223 CTS Microelectronics Lafayette, NY	25099 Cascade Gasket Kent, WA	28309 Kaiser Minette, AL
2B178 Wire Products Cleveland, OH	23237 I.R.C., Inc. Microcircuits Division Philadelphia, PA	25403 Amperex Electronic Corp. Semiconductor & Micro-Circuit Div. Slatersville, RI	28425 Serv-O-Link Euleess, TX
2K262 Boyd Corporation Portland, OR	23302 S.W. Electronics & Mfg. Corp. Cherry Hill, NJ	25435 Moldtronics, Inc Downers Grove, IL	28478 Deltrol Corporation Deltrol Controls Div. Milwaukee, WI
	23730 Mark Eyelet and Stamping Inc. Wolcott, CT	25706 Dabum Electronic & Cable Corp. Norwood, NJ	28480 Hewlett Packard Co. Corporate HQ Palo Alto, CA



## Federal Supply Codes for Manufacturers (cont)

28484 Emerson Electric Co. Gearmaster Div. McHenry, IL	31433 Kemet Electronics Corp. Simpsonville, NC	33246 Epoxy Technology Inc. Billerica, MA	36701 Van Waters & Rogers Valley Field, Quebec, Canada
28520 Heyco Molded Products Kenilworth, NJ	31448 Army Safeguard Logistics Command Huntsville, AL	33292 Pioneer Sterilized Wiping Cloth Co. Portland, OR	37942 Mallory Capacitor Corp. Sub of Emhart Industries INpolis, IN
28932 Lumax Industrials, Inc Altoona, PA	31471 Gould Inc Semiconductor Div Santa Clara, CA	33297 NEC Electronics USA Inc. Electronic Arrays Inc. Div. Mountain View, CA	39003 Maxim Industries Middleboro, MA
29083 Monsanto Co. Santa Clara, CA	31522 Metal Masters Inc. Baldwin, MS	33919 Nortek Inc. Cranston, RI	4F434 Plastic Sales Los Angeles, CA
29604 Stackpole Components Co. Raleigh, NC	31746 Cannon Electric Woodbury, TN	34114 Oak Industries Rancho Bernardo, CA	40402 Roderstein Electronics Inc. Statesville, NC
29907 Omega Engineering Inc. Stamford, CT	31827 Budwig Ramona, CA	34263 CTS Electronics Corp. Brownsville, TX	42498 National Radio Melrose, MA
3D536 Aimsco Inc. Seattle, WA	31918 ITT-Schadow Eden Prairie, MN	34333 Silicon General Inc. Garden Grove, CA	43543 Nytronics Inc. (Now 53342)
30035 Jolo Industries Inc. Garden Grove, CA	32293 Intersil Cupertino, CA	34335 Advanced Micro Devices (AMD) Sunnyvale, CA	43744 Panasonic Industrial Co. San Antonio, TX
30045 Solid Power Corp. Farmingdale, NY	32539 Mura Corp. Westbury, Long Island, N.Y.	34359 MN Mining & Mfg. Co. Commercial Office Supply Div. Saint Paul, MN	43791 Datron Systems Wilkes Barre, PA
30146 Symbex Corp. Painesville, OH	32559 Bivar Santa Ana, CA	34371 Harris Corp. Harris Semiconductor Products Group Melbourne, FL	44655 Ohmite Mfg. Co. Skokie, IL
30148 AB Enterprise Inc. Ahoskie, NC	32719 Siltronics Santa Ana, CA	34576 Rockwell International Corp. Newport Beach, CA	47001 Lumberg Inc. Richmond, VA
30161 Aavid Engineering Inc. Laconia, NH	32767 Griffith Plastics Corp. Burlingame, CA	34641 Instrument Specialties Eulees, TX	47379 ISOCOM Campbell, CA
30315 Itron Corp. San Diego, CA	32879 Advanced Mechanical Components Northridge, CA	34649 Intel Corp. Santa Clara, CA	49569 IDT (International Development & Trade) Dallas, TX
30323 IL Tool Works Inc. Chicago, IL	32897 Murata Erie North America Inc. Carlisle Operations Carlisle, Pennsylvania	34802 Electromotive Inc. Kenilworth, NJ	49671 RCA Corp. New York, NY
30800 General Instrument Corp. Capacitor Div. Hicksville, NY	32997 Bourns Inc. Trimpot Div. Riverside, CA	34848 Hartwell Special Products Placentia, CA	49956 Raytheon Company Executive Offices Lexington, MA
30838 Fastec Chicago, ILL	33025 M/A ComOmni Spectra, Inc. (Replacing Omni Spectra) Microwave Subsystems Div. Tempe, AZ	35009 Renfrew Electric Co. Ltd. IRC Div. Toronto, Ontario, Canada	5D590 Mostek Corp. Replaced by: SGS Thompson Microelec- tronics
31019 Solid State Scientific Inc. Willow Grove, PA	33096 CO Crystal Corp. Loveland, CO	35986 Amrad Melrose Park, IL	5F520 Panel Components Corp. Santa Rosa, CA
31091 Alpha Industries Inc. Microelectronics Div. Hatfield, PA	33173 General Electric Co. Owensboro, KY	36665 Mitel Corp. Kanata, Ontario, Canada	5P575 Nobel Electronics Suffern, NY
31323 Metro Supply Company Sacramento, CA			5W664 NDK Div. of Nihon Dempa Kogyo LTD Lynchburg, VA

## Federal Supply Codes for Manufacturers (cont)

5U802 Dennison Mfg. Co. Framingham, MA	51499 Amtron Corp. Boston, MA	52840 Western Digital Corp. Costa Mesa, CA	54937 DeYoung Mfg. Bellevue, WA
50088 SGS - Thomson Microelectronics Inc. Carrollton, TX	51506 Accurate Screw Machine Co. (ASMCO) Nutley, NJ	53021 Sangamo Weston Inc. (See 06141)	54590 RCA Corp. Electronic Components Div. Cherry Hill, NJ
50120 Eagle-Picher Industries Inc. Electronics Div. CO Springs, CO	51605 CODI Semiconductor Inc. Kenilworth, NJ	53036 Textool Co. Houston, TX	55026 American Gage & Machine Co. Simpson Electric Co. Div. Elgin, IL
50157 Midwest Components Inc. Muskegon, MS	51642 Centre Engineering Inc. State College, PA	53184 Xciton Corp. Lathan, NY	55112 Plessey Capacitors Inc. (Now 60935)
50356 Teac Corp. of America Industrial Products Div Montebello, CA	51705 ICO/Rally Palo alto, CA	53217 Technical Wire Products Inc. Santa Barbara, CA	55261 LSI Computer Systems Inc. Melville, NY
50364 MMI, Inc. (Monolithic Memories Inc) Military Products Div. Santa Clara, CA	51791 Statek Corp. Orange, CA	53342 Opt Industries Inc. Phillipsburg, NJ	55285 Bercquist Co. Minneapolis, MN
50472 Metal Masters, Inc. City of Industry, CA	51984 NEC America Inc. Falls Church, VA	53673 Thompson CSF Components Corp. (Semiconductor Div) Conaga Park, CA	55322 Samtech Inc. New Albany, IN
50541 Hypertronics Corp. Hudson, MA	52063 Exar Integrated Systems Sunnyvale, CA	53718 Airmold/W. R. Grese & Co. Roanoke Rapids, NC	55408 STI-CO Industries Co Buffalo, NY
50558 Electronic Concepts, Inc. Eatontown, NJ	52072 Circuit Assembly Corp. Irvine, CA	53848 Standard Microsystems Hauppauge, NY	55464 Central Semiconductor Corp. Hauppauge, NY
50579 Litronix Inc. Cupertino, CA	52152 MN Mining & Mfg. Saint Paul, MN	53894 AFIAM Inc. RanchoCA, CA	55557 Microwave Diode Corp. W.Stewartstown, NH
50891 Semiconductor Technology Stuart, FL	52333 API Electronics Haugpauge, Long Island, NY	53944 Glow-Lite Pauls Valley, OK	55566 R A F Electronic Hardware Inc. Seymour, CT
50934 Tran-Tec Corp Columbus, NE	52361 Communication Systems Piscataway, NJ	54178 Plasmetex Industries Inc. San Marcos, CA	55576 Synertek Santa Clara, CA
51167 Aries Electronics Inc. Frenchtown, NJ	52500 Amphenol, RF Operations Burlington, MA	54294 Shalleross Inc. Smithfield, NC	55680 Nichicon/America/Corp. Schaumburg, IL
51284 Mos Technology Norristown, PA	52525 Space-Lok Inc. Leroo Div. Burbank, CA	54453 Sullins Electronic Corp. San Marcos, CA	55943 D J Associates, Inc (Replaced Transcon Mfg.-24618) Fort Smith, AZ
51249 Heyman Mfg. Co. Cleveland, OH	52531 Hitachi Magnetics Edmore, MO	54473 Matsushita Electric Corp. (Panasonic) Secaucus, NJ	56282 Utek Systems Inc. Olathe, KS
51372 Verbatim Corp. Sunnyvale, CA	52745 Timco Los Angeles, CA	54492 Cinch Clamp Co., Inc. Santa Rosa, CA	56289 Sprague Electric Co. North Adams, MA
51398 MUPAC Corp. Brockton, MA	52763 Stettner-Electronics Inc. Chattanooga, TN	54583 TDK Garden City, NY	56365 Square D Co. Corporate Offices Palatine, IL
51406 Murata Erie, No. America Inc. (Also see 72982) Marietta, GA	52769 Sprague-Goodman Electronics Inc. Garden City Park, NY	54590 RCA Corp Distribution & Special Products Cherry Hill, NY	56375 WESCORP Div. Dal Industries Inc Mountain View, CA
	52771 Moniterm Corp. Amatrom Div. Santa Clara, CA	54869 Pihier International Corp. Arlington Heights, IL	

## Federal Supply Codes for Manufacturers (cont)

<p>56481 Shugart Associates Sub of Xerox Corp. Sunnyvale, CA</p>	<p>59610 Souriau Inc Valencia, CA</p>	<p>60911 Inmos Corp. CO Springs, CO</p>	<p>64537 KDI Electronics Whippany, NJ</p>
<p>56637 RCD Components Inc. Manchester, NH</p>	<p>59635 HV Component Associates Howell, NJ</p>	<p>60935 Westlake Capacitor Inc. Tantalum Div. Greencastle, IN</p>	<p>64782 Precision Control Mfg. Inc. Bellevue, WA</p>
<p>56708 Zilog Inc. Campbell, CA</p>	<p>59640 Supertex Inc. Sunnyvale, CA</p>	<p>60958 ACIC Intercomp Wire &amp; Cable Div. Hayesville, NC</p>	<p>64834 West M G Co. San Francisco, CA</p>
<p>56856 Vamistor Corp. of TN Sevierville, TN</p>	<p>59660 Tusonix Inc. Tucson, AZ</p>	<p>61271 Fujitsu Microelectronics Inc San Jose, CA</p>	<p>64961 Electronic Hardware LTD North Hollywood, CA</p>
<p>56880 Magnetics Inc. Baltimore, MD</p>	<p>59730 Thomas and Betts Corp. LA City, IA</p>	<p>61394 SEEQ Technology Inc. San Jose, CA</p>	<p>65092 Sangamo Weston Inc. Weston Instruments Div. Newark, NJ</p>
<p>57026 Endicott Coil Co. Inc. Binghamton, NY</p>	<p>59831 Semtronics Corp. Watchung, NJ</p>	<p>61429 Fox Electronics Cape Coral, FL</p>	<p>65786 Cypress Semi San Jose, CA</p>
<p>57053 Gates Energy Products Denver, CO</p>	<p>6I053: American Components Inc. an Insilco Co. RPC Div. Hayesville, NC</p>	<p>61529 Aromat Corp. New Providence, NJ</p>	<p>65940 Rohm Corp &amp; Whatney Irvine, CA</p>
<p>57170 Cambridge Thermionic Cambridge, MA Replaced by: 71279 Interconnection Products Inc.</p>	<p>6L611 Allen, Robert G. Inc. Van Nuys, CA</p>	<p>61752 IR-ONICS Inc Warwick, RI</p>	<p>65964 Evox Inc. Bannockburn, IL</p>
<p>57668 R-ohm Corp Irvine, CA</p>	<p>6U850 Burgess Switch Co., Inc Northbrook, IL</p>	<p>61772 Integrated Device Technology Santa Clara, CA</p>	<p>66150 Entron Inc. Winslow Teltronics Div. Glendale, NY</p>
<p>57962 SGS - Thomson Microelectronics Inc Montgomeryville, PA</p>	<p>6U095 AMD Enterprises, Inc. Roswell, GA</p>	<p>61802 Toshiba Houston, TX</p>	<p>66302 VLSI Technology Inc. San Jose, CA</p>
<p>58014 Hitachi Magnalock Corp. (Now 12581)</p>	<p>6X403 SGS/ATES Semiconductor Corp. INpolis, IN</p>	<p>61857 SAN-O Industrial Corp. Bohemia, Long Island, NY</p>	<p>66419 Exel San Jose, CA</p>
<p>58104 Simco Atlanta, GA</p>	<p>6Y440 Micron Technology Inc. Boise, ID</p>	<p>61935 Schurter Inc. Petaluma, CA</p>	<p>66450 Dyna-Tech Electronics, Inc Walled Lake, MI</p>
<p>58364 BYCAP Inc. Chicago, IL</p>	<p>60046 Power Dynamics Inc West Orange, NJ</p>	<p>62351 Apple Rubber Lancaster, NY</p>	<p>66608 Bering Industries Freemont, CA</p>
<p>58451 Precision Lamp Cotat, CA</p>	<p>60197 Precicontact Inc. Langhome, PA</p>	<p>62643 United Chemicon Rosemont, IL</p>	<p>66891 BKC International Electronics Lawrence, MA</p>
<p>58474 Superior Electric Co. Bristol, CT</p>	<p>60386 Squires Electronics Inc Cornelius, OR</p>	<p>62712 Seiko Instruments Torrance, CA</p>	<p>66958 SGS Semiconductor Corp. Phoenix, AZ</p>
<p>58614 Communications Instruments Inc. Fairview, NC</p>	<p>60395 Xicor Inc. Milpitas, CA</p>	<p>62793 Lear Siegler Inc. Energy Products Div. Santa Ana, CA</p>	<p>66967 Powerex Inc Auburn, NY</p>
<p>59124 KOA-Speer Electronics Inc. Bradford, PA</p>	<p>60399 Torin Engineered Blowers Div. of Clevepak Corp. Torrington, CT</p>	<p>63743 Ward Leonard Electric Co.Inc. Mount Vernon, NY</p>	<p>67183 Altera Santa Clara, CA</p>
<p>59422 Holmberg Electronics Irvine, CA</p>	<p>60496 Micrel Inc. Sunnyvale, CA</p>	<p>64154 Lamb Industries Portland, OR</p>	<p>68919 WIMA % Harry Levinson Co. Seattle, WA</p>
	<p>60705 Cera-Mite Corp. (formerly Sprague) Grafton, WI</p>	<p>64155 Linear Technology Milpitas, CA</p>	

Federal Supply Codes for Manufacturers (cont)

7F361 Richmond-Division of Dixico % Zellerbach Paper Co. Seattle, WA	71468 ITT Cannon Div. of ITT Fountain Valley, CA	73138 Beckman Industrial corp. Helipot Div. Fullerton, CA	75042 TRW Inc. IRC Fixed Resistors Philadelphia, PA
7F844 Moore Business Forms, Inc Seattle, WA	71482 General Instrument Corp. Clare Div. Chicago, IL	73168 Fenwal Inc. Ashland, MA	75297 Kester Solder Div. Litton Systems, Inc Des Plaines, IL
7G902 Textron Inc. Camcar Div. Rockford, IL	71590 Mepco/Centralab A North American Philips Co. Fort Dodge, IA	73293 Hughes Aircraft Co. Electron Dynamics Div. Torrance, CA	75376 Kurze-Kasch Inc. Dayton, OH
7J395 Universal Plastics Welshpool, WA	71707 Coto Corp. Providence, RI	73445 Amperex Electronic Corp. Hicksville, NY	75378 CTS Knights Inc. Sandwich, IL
7J696 AMD Plastics East Lake, OH	71744 General Instrument Corp. Lamp Div/Worldwide Chicago, IL	73559 Carlingswitch Inc. Hartford, CT	75382 Kulka Electric Corp. (Now 83330) Mount Vernon, NY
7K354 Omni Spectra Inc Los Altos, CA	71785 TRW Inc. Cinch Connector Div. Elk Grove Village, IL	73586 Circle F Industries Trenton, NJ	75569 Performance Semiconductor Corp. Sunnyvale, CA
7Z884 ALPS Seattle, WA	71984 Dow Coming Corp. Midland, MI	73734 Federal Screw Products Inc. Chicago, IL	75915 Littelfuse Tracor (Formerly: Tracor-Littelfuse) Des Plaines, IL
7X634 Duracell USA Div. of Dart & Kraft Inc. Valdese, NC	72005 AMAX Specialty Metals Corp. Newark, NJ	73743 Fischer Special Mfg. Co. Cold Spring, KY	76854 Oak Switch Systems Inc. Crystal Lake, IL
70290 Almetal Universal Joint Co. Cleveland, OH	72136 Electro Motive Mfg. Corp. Florence, NC	73893 Microdot Mt. Clemens, MS	77122 TRW Assemblies & Fasteners Group Fastener Div. Moutainside, NJ
70485 Atlantic India Rubber Works Inc. Chicago, IL	72228 AMCA International Corp. Continental Screw Div. New Bedford, MA	73899 JFD Electronic Components Div. of Murata Erie Oceanside, NY	77342 AMF Inc. Potter & Brumfield Div. Princeton, IN
70563 Amperite Company Union City, NJ	72259 Nytronics Inc. New York, NY	73905 FL Industries Inc. San Jose, CA	77542 Ray-O-Vac Corp Madison, WI
70903 Cooper-Belden Corp. Geneva, IL	72619 Amperex Electronic Corp. Dialight Div. Brooklyn, NY	73949 Guardian Electric Mfg. Co. Chicago, IL	77638 General Instrument Corp. Rectifier Div. Brooklyn, NY
71002 Bimbach Co. Inc. Farmingdale, NY	72653 G C Electronics Co. Div. of Hydrometals Inc. Rockford, IL	74199 Quam Nichols Co. Chicago, IL	77900 Shakeproof Lock Washer Co. (Now 78189)
71034 Biley Electric Co. Erie, PA	72794 Dzus Fastner Co. Inc. West Islip, NY	74217 Radio Switch Co. Marlboro, NJ	77969 Rubbercraft Corp. of CA Ltd. Torrance, CA
71183 Westinghouse Electric Corp. Bryant Div. Bridgeport, CT	72928 Gulton Industries Inc. Gudeman Div. Chicago, IL	74306 Piezo Crystal Co. Div. of PPA Industries Inc. Carlisle, PA	78189 IL Tool Works Inc. Shakeproof Div. Elgin, IL
71279 Interconnection Products Inc. Formerly Midland-Ross Cambion Div. Santa Ana, CA	72962 Elastic Stop Nut Div. of Harrard Industries Union, NJ	74445 Holo-Krome Co. Elmwood, CT	78277 Sigma Instruments Inc. South Braintree, MA
71400 Bussman Manufacturing Div. McGraw-Edison Co. St. Louis, MO	72982 Erie Specialty Products, Inc Formerly: Murata Erie Erie, PA	74542 Hoyt Elect.Instr. Works Inc. Penacook, NH	78290 Struthers Dunn Inc. Pitman, NJ
71450 CTS Corp. Elkhart, IN		74840 IL Capacitor Inc. Lincolnwood, IL	78553 Eaton Corp. Engineered Fastener Div. Cleveland, OH

Federal Supply Codes for Manufacturers (cont)

78592 Stoeger Industries South Hackensack, NJ	81439 Therm-O-Disc Inc. Mansfield, OH	83315 Hubbell Corp. Mundelein, IL	87034 Illuminated Products Inc. (Now 76854)
79497 Western Rubber Co. Goshen, IN	81483 International Rectifier Corp. Los Angeles, CA	83330 Kulka Smith Inc. A North American Philips Co. Manasquan, NJ	87516 Standard Crystal KS City, KS
79727 C - W Industries Southampton, PA	81590 Korry Electronics Inc. Seattle, WA	83478 Rubbercraft Corp. of America West Haven, CT	88044 Aeronautical Standards Group Dept. of Navy & Air Force
79963 Zierick Mfg. Corp. Mount Kisco, NY	81741 Chicago Lock Co. Chicago, IL	83553 Associated Spring Barnes Group Gardena, CA	88219 GNB Inc. Industrial Battery Div. Langhorne, PA
8C798 Ken-Tronics, Inc. Milan, IL	82227 Airpax Corp. Cheshire Div. Cheshire, CT	83740 Union Carbide Corp. Battery Products Div. Danbury, CT	88245 Winchester Electronics Litton Systems-Usecro Div. Van Nuys, CA
8D528 Baumgartens Atlanta, GA	82240 Simmons Fastner Corp. Albany, NY	84171 Arco Electronics Commack, NY	88486 Triangle PWC Inc. Jewitt City, CT
8F330 Eaton Corp. Cutler Hammer Product Sales Office Mountain View, CA	82305 Palmer Electronics Corp. South Gate, CA	84411 American Shizuki TRW Capacitors Div. Ogallala, NE	88690 Essex Group Inc. Wire Assembly Div. Dearborn, MI
8T100 Tellabs Inc. Naperville, IL	82389 Switchcraft Inc. Sub of Raytheon Co. Chicago, IL	84613 FIC Corp. Rockville, MD	88786 Atlantic India Rubber Co. Goshen, IN
80009 Tektronix Beaverton, OR	82415 Airpax Corp Frederick Div. Frederick, MD	84682 Essex Group Inc. Peabody, MA	88978 Phillips (Now Fluke) Mahwah, NJ
80031 Mepco/Electra Inc. Morristown, NJ	82872 Roanwell Corp. New York, NY	84830 Lee Spring Co. Inc Brooklyn, NY	89020 Amerace Corp. Buchanan Crimpool Products Div. Union, NJ
80032 Ford Aerospace & Communications Corp. Western Development Laboratories Div. Palo Alto, CA	82877 Rotron Inc. Custom Div. Woodstock, NY	85367 Bearing Distributing Co. San Fransisco, CA	89265 Potter-Brumfield (See 77342)
80145 LFE Corp. Process Control Div. Clinton, OH	82879 IIT Royal Electric Div. Pawtucket, RI	85372 Bearing Sales Co. Los Angeles, CA	89462 Waldes Truarc, Inc. Long Island, NY
80183 Sprague Products (Now 56289)	83003 Varo Inc. Garland, TX	85480 W. H. Brady Co. Industrial Product Milwaukee, WI	89536 John Fluke Mfg. Co., Inc. Everett, WA
80294 Boums Instruments Inc. Riverside, CA	83014 Hartwell Corp. Placentia, CA	85840 Brady WH Co Industrial Products Div Milwaukee, WI	89597 Fredericks Co. Huntingdon Valley, PA
80583 Hammerlund Mfg. Co. Inc. Paramus, NJ	83055 Signalite Fuse Co. (Now 71744)	85932 Electro Film Inc. Valencia, CA	89709 Bunker Ramo-Eltra Corp. Amphenol Div. Broadview, IL
80640 Computer Products Inc. Stevens-Arnold Div. South Boston, MA	83058 TRW Assemblies & Fasteners Group Fasteners Div. Cambridge, MA	86577 Precision Metal Products Co. Peabody, MA	89730 General Electric Lamp Div. Newark, NJ
81073 Grayhill Inc. La Grange, IL	83259 Parker-Hannifin Corp. O-Seal Div. Culver City, CA	86684 Radio Corp. of America (Now 54590)	9R216 Data Composition Svc, Inc Laurel, MD
81312 Litton Systems Inc. Winchester Electronics Div. Watertown, CT	83298 Bendix Corp. Electric & Fluid Power Div. Eatonville, NJ	86928 Seastrom Mfg. Co. Inc. Glendale, CA	9S171 Port Plastics Tukwila, WA

## Federal Supply Codes for Manufacturers (cont)

9W423 Amatom El Mont, CA	91934 Miller Electric Co. Woonsocket, RI	95573 Campion Laboratories Inc. Detroit, MI	98278 Malco A Microdot Co. South Pasadena, CA
90201 Mallory Capacitor Co. Sub of Emhart Industries Inc. Indianapolis, IN	91967 National Tel-Tronics Div. of electro Audio Dynamics Inc Meadville, PA	95712 Bendix Corp. Electrical Comp. Div. Franklin, IN	98291 Sealectro Corp. BICC Electronics Trumbull, CT
90215 Best Stamp & Mfg. Co. KS City, MO	91984 Maida Development Co. Hampton, VA	95987 Weckesser Co. Inc. (Now 85480)	98372 Royal Industries Inc. (Now 62793)
90303 Duracell Inc. Technical Sales & Marketing Bethel, CT	91985 Norwalk Valve Co. S. Norwalk, CT	96733 SFE Technologies San Fernando, CA	98388 Lear Siegler Inc. Accurate Products Div. San Deigo, CA
91094 Essex Group Inc. Suflex/IWP Div. Newmarket, NH	92218 Wakefield Corp., The Wakefield, ME	96853 Gulton Industries Inc. Measurement & Controls Div. Manchester, NH	98978 IERC (International Electronic Research Corp.) Burbank, CA
91247 IL Transformer Co. Chicago, IL	92527 VTC Inc. Bloomington, MN	96881 Thomson Industries Inc. Port WA, NY	99120 Plastic Capacitors Inc. Chicago, IL
91293 Johanson Mfg. Co. Boonton, NJ	92607 Tensolite Co. Div. of Carlisle Corp. Buchanan, NY	97464 Industrial Retainer Ring Irvington, NJ	99217 Bell Industries Inc. Elect. Distributor Div. Sunnyvale, CA
91462 Alpha Industries Inc. Logansport, IN	92914 Alpha Wire Corp. Elizabeth, NJ	97525 EECO Inc. Santa Ana, CA	99378 ATLEE of DE Inc. N. Andover, MA
91502 Associated Machine Santa Clara, CA	93332 Sylvania Electric Products Semiconductor Products Div. Woburn, MA	97540 Whitehall Electronics Corp. Master Mobile Mounts Div. Fort Meyers, FL	99392 Mepco/Electra Inc. Roxboro Div. Roxboro, NC
91506 Augat Alcoswitch N. Andover, MA	94144 Raytheon Co. Microwave & Power Tube Div. Quincy, MA	97913 Industrial Electronic Hardware Corp. NY, NY	99515 Electron Products Inc. Div. of American Capacitors Duarte, CA
91507 Froeliger Machine Tool Co. Stockton, CA	94222 Southco Inc. Concordville, PA	97945 Pennwalt Corp. SS White Industrial Products Piscataway, NJ	99779 Bunker Ramo- Eltra Corp. Barnes Div. Lansdown, PA
91637 Dale Electronics Inc. Columbus, NE	94988 Wagner Electric Corp. Sub of McGraw-Edison Co. Whippany, NJ	97966 CBS Electronic Div. Danvers, MA	99800 American Precision Industries Delevan Div. East Aurora, NY
91662 Elco Corp. A Gulf Western Mfg. Co. Connector Div. Huntingdon, PA	95146 Alco Electronic Products Inc. Switch Div. North Andover, MA	98094 Machlett Laboratories Inc. Santa Barbara, CA	99942 Mepco/Centralab A North American Philips Co. Milwaukee, WI
91737 ITT Cannon/Gremar (Now 08718)	95263 Leecraft Mfg. Co. Long Island City, NY	98159 Rubber-Teck Inc. Gardena, CA	
91802 Industrial Devices Inc. Edgewater, NJ	95275 Vitramon Inc. Bridgeport, CT		
91833 Keystone Electronics Corp. NY, NY	95303 RCA Corp. Receiving Tube Div. Cincinnati, OH		
91836 King's Electronics Co. Inc. Tuckahoe, NY	95348 Gordo's Corp. Bloomfield, NJ		
91929 Honeywell Inc. Micro Switch Div. Freeport, IL	95354 Methode Mfg. Corp. Rolling Meadows, IL		

## TECHNICAL SERVICE CENTERS

---

### U.S. Service Locations

#### California

Fluke Technical Center  
16969 Von Karman Avenue  
Suite 100  
Irvine, CA 92714  
Tel: (714) 863-9031

Fluke Technical Center  
46610 Landing Parkway  
Fremont, CA 94538  
Tel: (415) 651-5112

#### Colorado

Fluke Technical Center  
14180 East Evans Avenue  
Aurora, CO 80014  
Tel: (303) 695-1171

#### Florida

Fluke Technical Center  
940 N. Fern Creek Avenue  
Orlando, FL 32803  
Tel: (407) 896-4881

#### Illinois

Fluke Technical Center  
1150 W. Euclid Ave.  
Palatine, IL 60067  
Tel: (312) 705-0500

#### Maryland

Fluke Technical Center  
5640 Fishers Lane  
Rockville, MD 20852  
Tel: (301) 770-1576

#### New Jersey

Fluke Technical Center  
East 66 Midland Avenue  
Paramus, NJ 07652-0930  
Tel: (201) 599-9500

#### Texas

Fluke Technical Center  
1801 Royal Lane, Suite 307  
Dallas, TX 75229  
Tel: (214) 869-2848

#### Washington

Fluke Technical Center  
John Fluke Mfg. Co., Inc.  
1420 75th St. S.W.  
M/S 6-30  
Everett, WA 98203  
Tel: (206) 356-5560

### International

#### Argentina

Coasin S.A.  
Virrey del Pino 4071 DPTO E-65  
1430 CAP FED  
Buenos Aires  
Tel: 54 1 522-5248

#### Australia

Philips Customer Support  
Scientific and Industrial  
23 Lakeside Drive  
Tally Ho Technology Park  
East Burwood  
Victoria 3151

#### Australia

Philips Customer Support  
Scientific & Industrial  
25-27 Paul St. North  
North Ryde N.S.W. 2113  
Tel: 61 02 888 8222

#### Austria

Oesterreichische Philips Industrie  
Unternehmensbereich Prof. Systeme  
Triesterstrasse 66  
Postfach 217  
A-1101 Wein  
Tel: 43 222-60101, x1388

#### Belgium

Philips & MBL Associated S.A.  
Scientific & Industrial Equip. Div  
Service Department.  
80 Rue des deux Gares B-1070  
Brussels  
Tel: 32 2 525 6111

#### Brazil

Hi-Tek Electronica Ltda.  
Al. Amazonas 422, Alphaville  
CEP 06400 Barueri  
Sao Paulo  
Tel: 55 11 421-5477

#### Canada

Fluke Electronics Canada Inc.  
400 Britannia Rd. East, Unit #1  
Mississauga  
Ontario L4Z 1X9  
Tel: 416-890-7600

#### Chile

Intronica Chile Ltda.  
Casilla 16228  
Santiago 9  
Tel: 56 2 2321886, 2324308

#### China

Fluke International Corp.  
P.O. Box 9085  
Beijing  
Tel: 86 01 512-3436

#### Colombia

Sistemas E Instrumentacion, Ltda.  
Carrera 13, No. 37-43, Of. 401  
Ap. Aereo 29583  
Bogota DE  
Tel: 57 232-4532

#### Denmark

Philips A/S  
Technical Service I & E  
Strandlodsvej 1A  
PO Box 1919  
DK-2300  
Copenhagen S  
Tel: 45 1 572222

#### Ecuador

Proteco Coasin Cia., Ltda.  
P.O. Box 228-A  
Ave. 12 de Octubre  
2285 y Orellana  
Quito  
Tel: 593 2 529684

#### Egypt

Philips Egypt  
10, Abdel Rahman el Rafei st.  
el. Mohandessin  
P.O. Box 242  
Dokki Cairo  
Tel: 20-2-490922

#### England

Philips Scientific  
Test & Measuring Division  
Colonial Way  
Watford  
Hertfordshire WD2 4TT  
Tel: 44 923-40511

#### Finland

Oy Philips AB  
Central Service  
Sinikalliontie 1-3  
P.O. Box 11  
SF-02630 ESPOO  
Tel: 358-0-52572

#### France

S.A. Philips Industrielle  
et Commerciale,  
Science et Industry  
105 Rue de Paris Bp 62  
93002 Bobigny, Cedex  
Tel: 33-1-4942-8040

#### Germany (F.R.G.)

Philips GmbH  
Service fuer FLUKE - Produkte  
Department VSF  
Oskar-Messter-Strasse 18  
D-8045 Ismaning/Munich,  
West Germany  
Tel: 49 089 9605-239

#### Greece

Philips S.A. Hellenique  
15, 25th March Street  
177 78 Tavros  
10210 Athens  
Tel: 30 1 4894911

#### Hong Kong

Schmidt & Co (H.K.) Ltd.  
18/FL., Great Eagle Centre  
23 Harbour Road  
Wanchai  
Tel: 852 5 8330222

#### India

Hinditron Services Pvt. Ltd  
1st Floor, 17-B,  
Mahal Industrial Estate  
Mahakali Road, Andheri East  
Bombay 400 093  
Tel: 91 22 6300043

Hinditron Services Pvt. Inc.  
33/44A Raj Mahal Villas Extn.  
8th Main Road  
Bangalore 560 080  
Tel: 91 812 363139

#### Hinditron Services Pvt. Ltd.

Field Service Center  
Emerald Complex 1-7-264  
5th Floor  
114 Sarojini Devi Road  
Secunderabad 500 003  
Tel: 08 42-821117

#### Hinditron Services Pvt. Ltd.

15 Community Centre  
Panchshila Park  
New Delhi 110 017  
Tel: 011-6433675

#### Indonesia

P.T. Lamda Triguna  
P.O. Box 6/JATJG  
Jakarta 13001  
Tel: (021) 8195365

#### Israel

R.D.T. Electronics Engineering, Ltd.  
P.O. Box 43137  
Tel Aviv 61430  
Tel: 972 3 483211

#### Italy

Philips S.p.A.  
Sezione I&E / T&M  
Viale Elvezia 2  
2005 Monza  
Tel: 39 39 3635342

#### Japan

John Fluke Mfg. Co., Inc.  
Japan Branch  
Sumitomo Higashi Shinbashi Bldg.  
1-1-11 Hamamatsucho  
Minato-ku  
Tokyo 105  
Tel: 81 3 434-0181

#### Korea

Myoung Corporation  
Yeo Eui Do P.O. Box 14  
Seoul 150  
Tel: 82 2 784-9942

#### Malaysia

Mecomb Malaysia Sdn. Bhd.  
P.O. Box 24  
46700 Petaling Jaya  
Selangor  
Tel: 60 3 774-3422

#### Mexico

Mexel Servicios en Computacion  
Instrumentacion y Perifericos  
Blvd. Adolfo Lopez Mateos No. 163  
Col. Mixcoac  
Mexico D.F.  
Tel: 52-5-563-5411

#### Netherlands

Philips Nederland  
Test & Meetapparaten Div.  
Postbus 115  
5000 AC Tilburg  
Tel: 31-13-352445

**New Zealand**

Philips Customer Support  
Scientific & Industrial Division  
2 Wagener Place  
Mt. Albert  
Auckland  
Tel: 64 9 894-160

**Norway**

Morgenstjerne & Co. A/S  
Konghellegate 3  
P.O. Box 6688, Rodelokka  
Oslo 5  
Tel: 47 2 356110

**Pakistan**

International Operations (PAK) Ltd.  
505 Muhammadi House  
I.I. Chundrigar Road  
P.O. Box 5323  
Karachi  
Tel: 92 21 221127, 239052

**Peru**

Importaciones & Representaciones  
Electronicas S.A.  
Avad Franklin D. Roosevelt 105  
Lima 1  
Tel: 51 14 288650

**Philippines**

Spark Radio & ElectronicS Inc.  
Greenhills, P.O. Box 610  
San Juan, Metro-Manila Zip 3113  
Tel: 63-2-775192

**Portugal**

Decada Espectral  
Equipmentos de Elec. e Cientificos  
Av. Bomberos Voluntarios  
Lote 102B, Miraflores/Alges  
1495 Lisboa  
Tel: 351 1 410-3420

**Singapore**

Rank O'Connor's Singapore (PTE) Ltd.  
98 Pasir Panjang Road  
Singapore 0511  
Tel: 65 4737944

**South Africa**

South African Philips (Pty) Ltd.  
Service Department  
195 Main Rd  
Martindale, Johannesburg, 2092  
Tel: 27 11 470-5255

**Spain**

Philips Iberica S.A.E.  
Depto. Tecnico Instrumentacion  
c/Martinez Villergas 2  
28027 Madrid  
Tel: 34 1 4042200

**Sweden**

Philips Kistaindustrier AB  
Customer Support  
Borgarfjordsgatan 16  
S-16493 Kista

**Switzerland**

Philips A.G.  
Technischer Kundendienst  
Postfach 670  
Allmendstrasse 140  
CH-8027 Zurich  
Tel: 41 1 482211

**Taiwan**

Schmidt Electronics Corp.  
5th Floor, Cathay Min Sheng  
Commercial Building,  
344 Min Sheng East Road  
Taipei  
Tel: 886 2501-3468

**Thailand**

Measuretronix Ltd.  
2102/63 Ramkamhaeng Rd.  
Bangkok 10240  
Tel: 66 2 374-2516, 374-1632

**Turkey**

Turk Philips Ticaret A.S.  
Inonu Caddesi 78/80  
Posta Kutusu 504-Beyoglu  
Istanbul  
Tel: 90 1 1435891

**Uruguay**

Coasin Uruguay S.A  
Casilla de Correo 1400  
Libertad 2525  
Montevideo  
Tel: 598-2-789015

**Venezuela**

Coasin C.A.  
Calle 9 Con Calle 4, Edif. Edinurbi  
Apartado de Correos Nr-70-136  
Los Ruices  
Caracas 1070-A  
Tel: 58 2 241-0309, 241-1248

**West Germany**

Philips GmbH  
Department VSF  
Service fuer FLUKE - Produkte  
Oskar - Messter - Strasse 18  
D-8045 Ismaning / Munich  
Tel: 49 089 9605-260



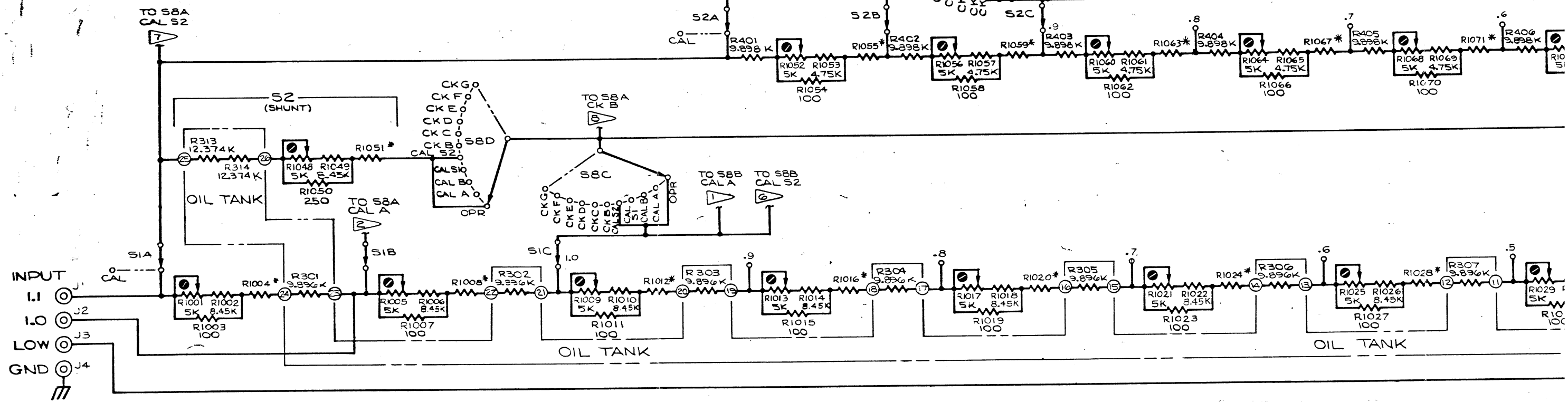
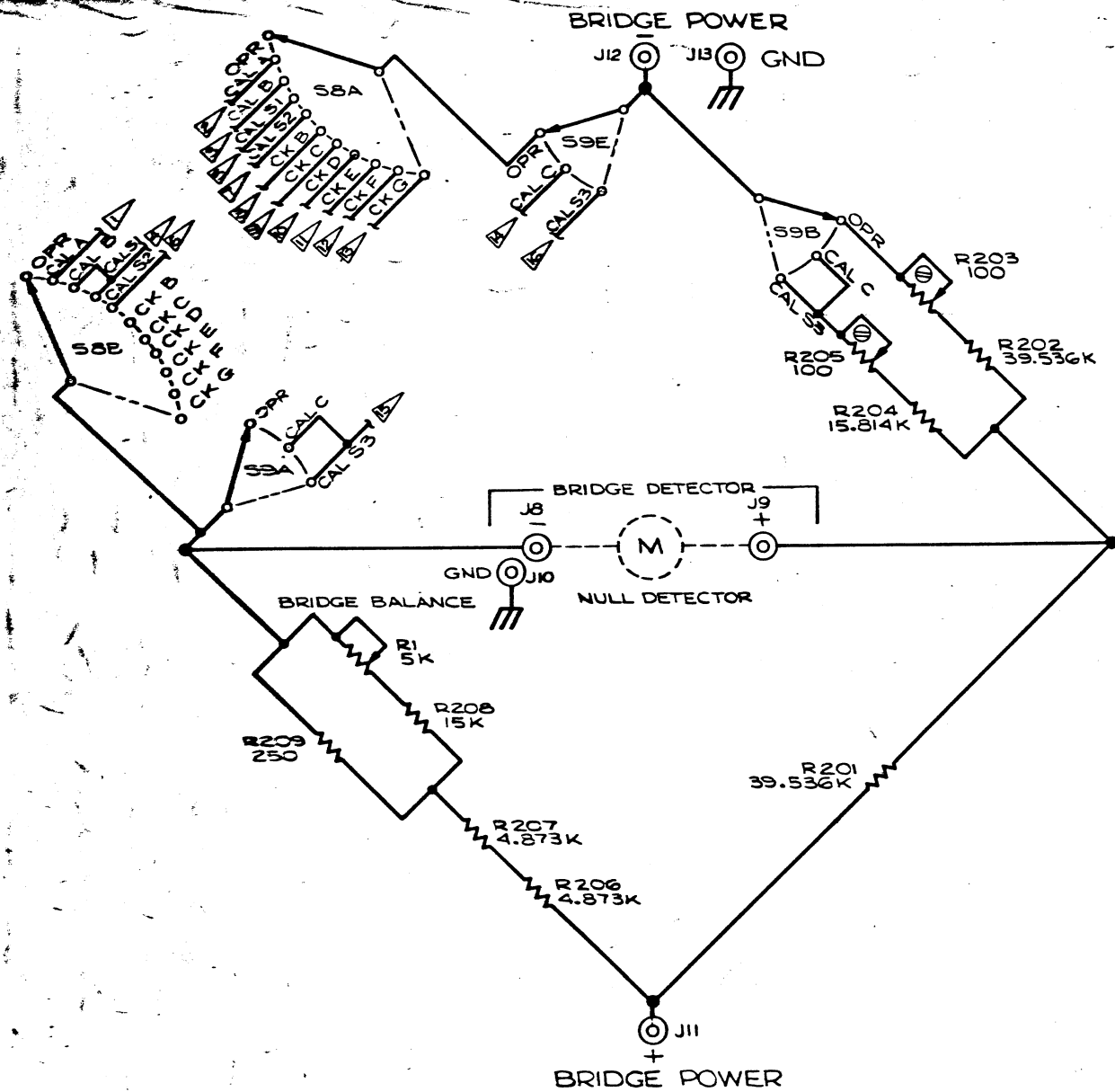

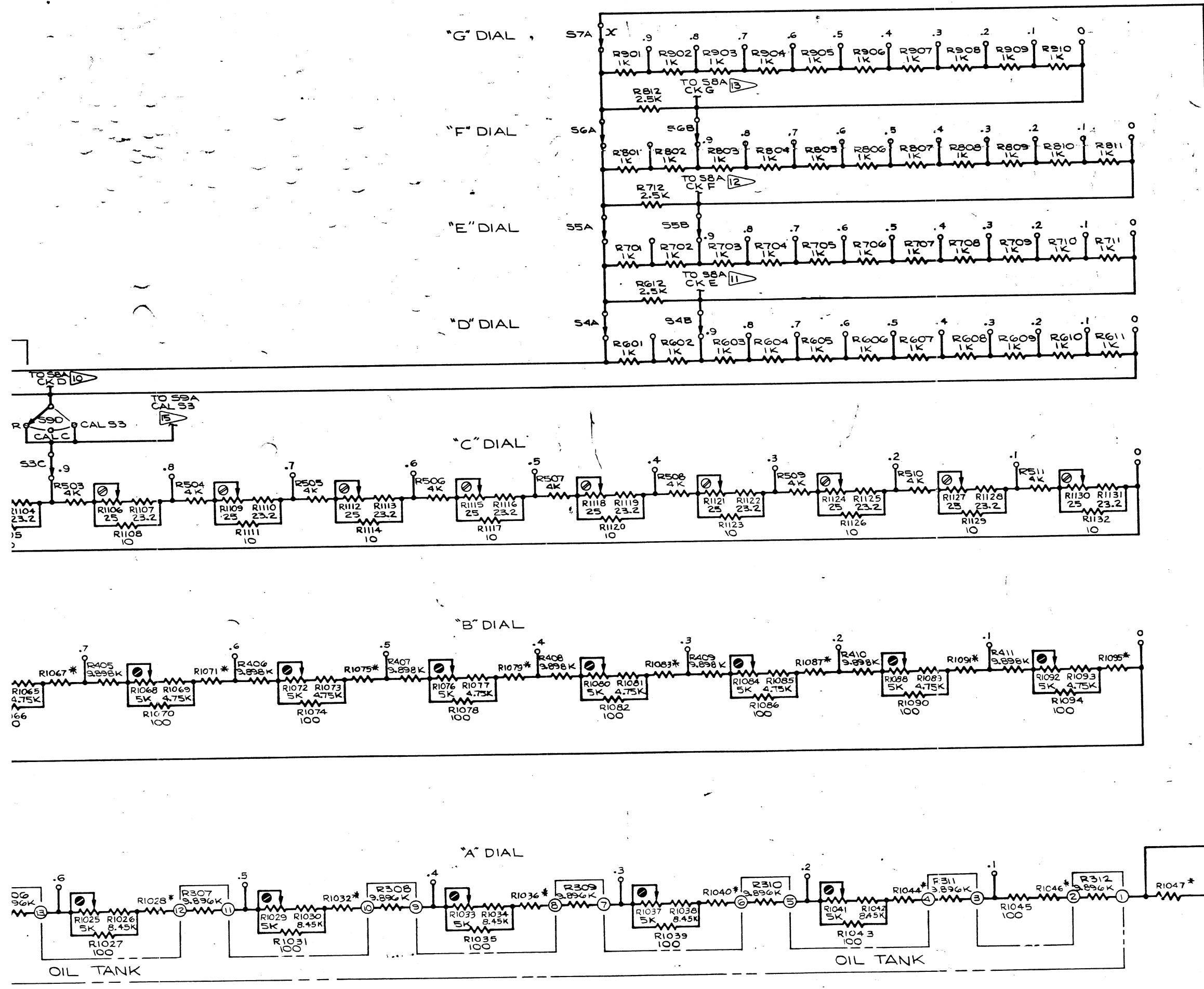

- NOTES:
- RESISTORS DESIGNATED R301 THROUGH R312 ARE ACTUALLY FOUR RESISTORS IN SERIES AS SHOWN BELOW
  - \* INDICATES FACTORY SELECTED COMPONENT
  - ALL RESISTANCES ARE IN OHMS
  - ⊙ INDICATES INTERNAL ADJUSTMENT
  - ⊙ INDICATES INTERNAL ADJUSTMENT ACCESSIBLE THROUGH FRONT PANEL
  - ▶ FLAG NOTES WITH THE SAME NUMBERS ARE CONNECTED
  - ⏏ CHASSIS GROUND

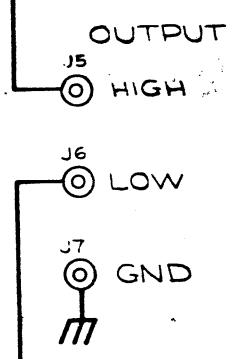

FUNCTIONAL SCHEMATIC DIAGRAM

MODEL 720A  
KELVIN-VARLEY  
VOLTAGE DIVIDER

SER. NO. 123 & ON

FLUKE JOHN FLUKE MFG. CO. INC.  
P.O. Box 1428 Seattle, Wn. 98111